

NEWS 2022

**Poliform**



**Poliform**

Poliform presenta in anteprima i nuovi prodotti dedicati alla zona giorno e alla zona notte. Divani, poltrone e sedute dove design e comfort trovano il perfetto equilibrio; tavoli, tavolini e madie dall'estetica essenziale; due nuovi letti che celebrano il legame tra i diversi ambienti della casa. Uno stile che sempre di più diventa lifestyle, anche grazie a pezzi decorativi come il paravento e lo sgabello, un pezzo di rottura dall'aspetto scultoreo e contemporaneo che guarda al mondo dell'arte.

Poliform presents a preview of the new products dedicated to the day and night areas. Sofas, armchairs and chairs that strike the perfect balance of design and comfort. Tables, coffee tables and sideboards with an essential design; two new beds that celebrate the link between different environments in the house. A style that increasingly becomes lifestyle, also thanks to decorative pieces such as the room divider and stool, an element of rupture with a sculptural and contemporary look that nods to the art world.

2022

A raccontare il punto di vista di Poliform sull'abitare contemporaneo sono Jean-Marie Massaud ed Emmanuel Gallina. Con il divano Brera, Jean-Marie Massaud riporta nel living la forza delle linee architettoniche. Linee morbide e curve caratterizzano invece la poltrona Kaori e lo sgabello Ube, un piccolo oggetto prezioso come un'opera d'arte. Lineari ed essenziali le madie della collezione Aiko, così come il paravento Hima, complemento trasversale capace di creare angoli d'intimità in qualsiasi ambiente. La zona notte di Massaud è all'insegna della semplicità con il letto imbottito Yume. Forme organiche e curve delicate sono invece la cifra stilistica di Emmanuel Gallina, che con Curve celebra la capacità di Poliform di creare un legame stilistico tra i diversi ambienti della casa.

Jean-Marie Massaud and Emmanuel Gallina express Poliform's point of view on contemporary living. With the Brera sofa, Jean Marie Massaud transports the strength of architectural lines into the world of interiors. Soft, curved lines characterise the Kaori armchair and the Ube stool, a small precious object like an artwork. The sideboard in the Aiko collection is linear and essential, and so is the Hima room divider, a versatile piece of furniture that is able to create intimate corners in any environment. The Massaud night area has a simple design with the padded Yume bed. Organic forms and delicate curves characterise the style of Emmanuel Gallina. With Curve, the designer celebrates Poliform's ability to create a style that brings together the different areas of the home.

## COLLECTIONS

BRERA SOFA	9
MUSH COFFEE TABLE	51
KAORI ARMCHAIR	67
CURVE ARMCHAIR	85
UBE STOOL	97
NARA BENCH AND CONSOLE	105
HIMA SCREEN	117
AIKO SIDEBOARD	129
CURVE TABLE	149
CURVE CHAIR	165
YUME BED	185
CURVE BED	197
SENZAFINE MATCH	209
SENZAFINE PLUS GLASS	219
SHINDO CARPET	227
NEW FABRICS	233
BRERA SOFA COMPOSITIONS	241
TECHNICAL DATA	267

# BRERA

Jean-Marie Massaud disegna un paesaggio domestico dalla forte connotazione architettonica, il cui protagonista è Brera, un sistema di divani dove l'eleganza si esprime attraverso un segno orizzontale, pulito e contemporaneo. Diverse le conformazioni possibili, da quella lineare classica a quella curva, destinata agli spazi più ampi e alle aree lounge. Altissimo il livello di comfort, grazie a cuscini che trasportano la tecnologia del riposo nel living, mentre la sartorialità è enfatizzata dai dettagli couture in cuoio e dalla nuova selezione di tessuti, che fa risaltare le cuciture come particolari preziosi.

Jean-Marie Massaud designs a domestic landscape with a strong architectural quality. Its protagonist is Brera, a sofa system where elegance is expressed through a horizontal, clean and contemporary design. Different configurations are possible, from the classic linear one to the curved one, best suited to larger spaces and lounge areas. The level of comfort is extremely high, thanks to pillows that embody relaxation-enhancing technology. A sartorial quality is emphasised by couture details in hide and a new selection of fabrics, which make the seams stand out like precious details.









Qui e nelle pagine precedenti: divano Brera con rivestimento sfoderabile in tessuto Kiala 01 avorio, cuscini in tessuto Yushan 03 avorio e Janaki 01 avorio, basamento e bracciolo Slim in cuoio 28 avorio, piedini brown nickel opaco.

Here and previous pages: Brera sofa with removable cover in fabric Kiala 01 avorio, cushions in fabric Yushan 03 avorio and Janaki 01 avorio, base and Slim armrest in hide 28 avorio, mat brown nickel feet.



Qui e nella pagina precedente: divano Brera con rivestimento sfoderabile in tessuto Kiala 06 wenge, cuscini in tessuto Yushan 04 talpa e Janaki 06 wenge, basamento e bracciolo Slim in cuoio 02 nero, piedini brown nickel opaco.

Here and previous page: Brera sofa with removable cover in fabric Kiala 06 wenge, cushions in fabric Yushan 04 talpa and Janaki 06 wenge, base and Slim armrest in hide 02 nero, mat brown nickel feet.





Qui e nella pagina precedente: divano Brera con rivestimento sfoderabile in tessuto Molai 04 creta, cuscini in tessuto Yushan 01 sabbia e in velluto Persia 1404 carbone, basamento e mensola in cuoio 08 fango, piedini brown nickel opaco. Tavolini Mush, piano in olmo nero e marmo zecevo levigato con struttura in olmo nero, rotondi con piano e struttura in cuoio 26 invecchiato. Poltrone Curve in olmo nero e tessuto non sfoderabile Siro 01 bianco. Paravento Hima con struttura in brown nickel opaco e corda nel colore cenere. Tappeto Shindo grey.

Here and previous page: Brera sofa with removable cover in fabric Molai 04 creta, cushions in fabric Yushan 01 sabbia and velvet Persia 1404 carbone, base and shelf in hide 08 fango, mat brown nickel feet. Mush coffee tables, top in black elm and mat zecevo marble with structure in black elm, round with top and structure in hide 26 invecchiato. Curve armchairs in black elm and Siro 01 bianco non-removable fabric. Hima screen with structure in mat brown nickel and rope in the colour cenere. Shindo carpet grey.





Qui e nella pagina precedente: divano Brera con rivestimento sfoderabile in tessuto Molai 01 sabbia, cuscini in tessuto Janaki 01 avorio, basamento, bracciolo Slim e mensola in cuoio 07 castagna, piedini brown nickel opaco. A destra: dettaglio del bracciolo Slim in cuoio.

Here and previous page: Brera sofa with removable cover in fabric Molai 01 sabbia, cushions in fabric Janaki 01 avorio, base, Slim armrest and shelf in hide 07 castagna, mat brown nickel feet. Right: close up of the Slim armrest in hide.









Qui e nella pagina precedente: divano Brera con rivestimento sfoderabile in tessuto Molai 01 sabbia, cuscini in tessuto Janaki 01 avorio, basamento, bracciolo Slim e mensola in cuoio 07 castagna, piedini brown nickel opaco. A sinistra: dettaglio della mensola in cuoio.

Here and previous page: Brera sofa with removable cover in fabric Molai 01 sabbia, cushions in fabric Janaki 01 avorio, base, Slim armrest and shelf in hide 07 castagna, mat brown nickel feet. Left: close up of the shelf in hide.



Qui e nella pagina precedente: divani Brera con rivestimento sfoderabile in tessuto Kiala 02 champagne, cuscini in tessuto Janaki 01 avorio, basamento e bracciolo Slim in cuoio 07 castagna, piedini brown nickel opaco. Tavolini Mush, al centro piani in olmo nero e marmo sahara noir levigato finitura poliестere, struttura in olmo nero; accanto ai divani piano e struttura in cuoio 07 castagna. Sgabelli Ube in legno massello tinto olmo nero. Tappeto Plain natural.

Here and previous page: Brera sofas with removable cover in fabric Kiala 02 champagne, cushions in fabric Janaki 01 avorio, base and Slim armrest in hide 07 castagna, mat brown nickel feet. Mush coffee tables, in the centre tops in black elm and mat sahara noir marble with polyester finish, structure in black elm; next to the sofas, top and structure in hide 07 castagna. Ube stools in solid wood stained black elm. Plain carpet natural.





Qui e nella pagina successiva: divano Brera con rivestimento sfoderabile in tessuto Naxos 16 sabbia, cuscini in tessuto Yushan 06 mattone e velluto Persia 1404 carbone, basamento e bracciolo Slim in cuoio 26 invecchiato, piedini brown nickel opaco.

Here and next page: Brera sofa with removable cover in fabric Naxos 16 sabbia, Yushan 06 mattone and velvet Persia 1404 carbone cushions, base and Slim armrest in hide 26 invecchiato, mat brown nickel feet.





In questa pagina: dettaglio del cuscino seduta del divano Brera in tessuto sfoderabile Naxos 16 sabbia con il basamento in cuoio 26 invecchiato.

This page: close up of the Brera sofa seat cushion in removable fabric Naxos 16 sabbia with base in hide 26 invecchiato.





Qui e nella pagina precedente: divano Brera con rivestimento sfoderabile in tessuto Kiala 05 giada, cuscini in tessuto Janaki 05 giada, basamento in cuoio 07 castagna, piedini brown nickel opaco. Tavolino Mush con piano e struttura in cuoio 07 castagna. Armadio Senzafine Match con ante battenti in tessuto lino chiaro, profili e maniglie Match champagne opaco.

Here and previous page: Brera sofa with removable cover in fabric Kiala 05 giada, Janaki 05 giada cushions, hide 07 castagna base, mat brown nickel feet. Mush coffee table with top and structure in hide 07 castagna. Senzafine Match wardrobe with leaf doors in fabric lino chiaro, mat champagne profiles and Match handles.



## BRERA

Design Jean-Marie Massaud

Struttura in legno e derivati. Cuscino schienale in poliuretano espanso a quote differenziate, cuscino seduta in poliuretano espanso a quote differenziate e molle, prerivestimento in tela cotone e piuma. Cuscino poggiatesta in tela cotone e piuma, struttura in metallo rivestita in cuoio colori. Cuscini opzionali in tela cotone e piuma. Mensola e bracciolo Slim in legno e derivati, struttura in metallo, rivestiti in cuoio colori, vassoio opzionale in olmo nero. Basamento in legno e derivati rivestito in cuoio colori. Piedini in fusione di alluminio e struttura in metallo verniciati brown nickel opaco. Rivestimento sfoderabile in tessuto o pelle.

Structure in wood and wood-derivative products. Backrest cushion in multi-density polyurethane foam, seat cushion in multi-density polyurethane foam and springs, pre-cover in cotton canvas and down. Headrest cushion in cotton canvas and down, metal structure covered in hide in the sample colours. Optional cushions in cotton canvas and down. Shelf and Slim armrest in wood and wood-derivative products, structure in metal, cover in hide as per sample colours, optional tray in black elm. Base in wood and wood-derivative products covered in hide in the sample colours. Feet in aluminium casting and structure in metal painted matt brown nickel. Removable cover in fabric or leather.

### Tipologie componenti Components typology

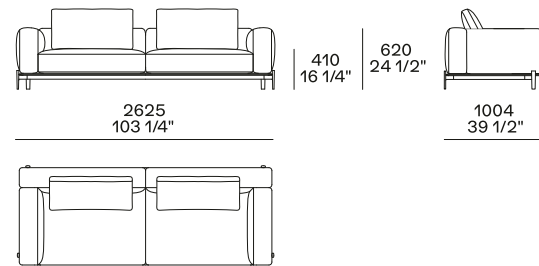

divano con due braccioli  
sofa with two arms

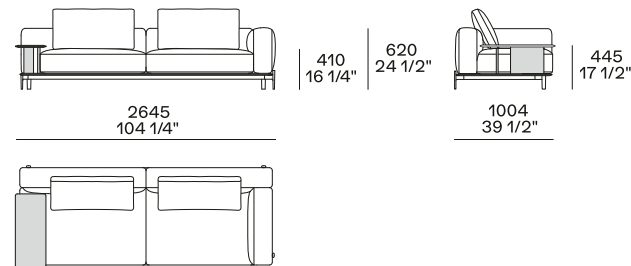

divano con un bracciolo Slim e un bracciolo  
sofa with one Slim arm and one arm

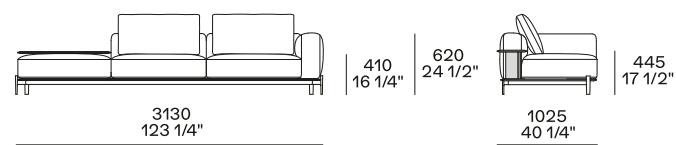

divano con mensola e un bracciolo  
sofa with shelf and one arm



divano senza bracciolo e con mensola  
sofa without arm and with shelf

### Tipologie piedino Feet types



piedino di serie  
standard feet



piedino opzionale  
optional feet

#### NB

Il divano è disponibile in due altezze:  
- h bracciolo/schiena 620,  
seduta h 410, piedino di serie  
- h bracciolo/schiena 640,  
seduta h 430, piedino opzionale

The sofa is available in two heights:  
- h arm/backrest 24 1/2",  
seat h 16 1/4", standard feet  
- h arm/backrest 25 1/4",  
seat h 17", optional feet

### Cuscini schienale Backrest cushions

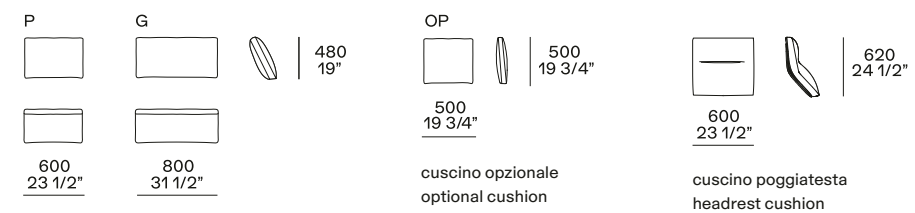

Il cuscino poggiatesta può sostituire un cuscino schienale da 1600 o 800. The headrest cushion can replace one backrest cushion w 23 1/2" or 31 1/2".

### Divano Sofa

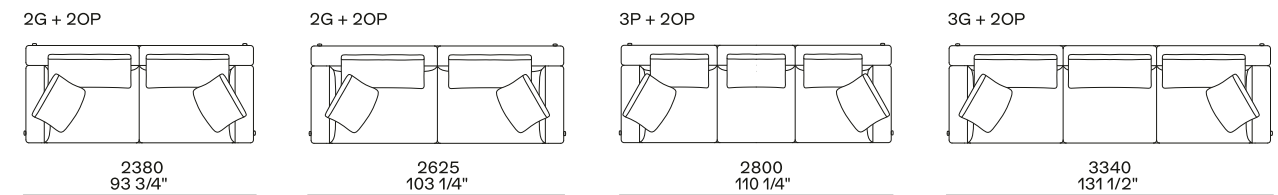

### Divano sx-dx Lt-rt sofa

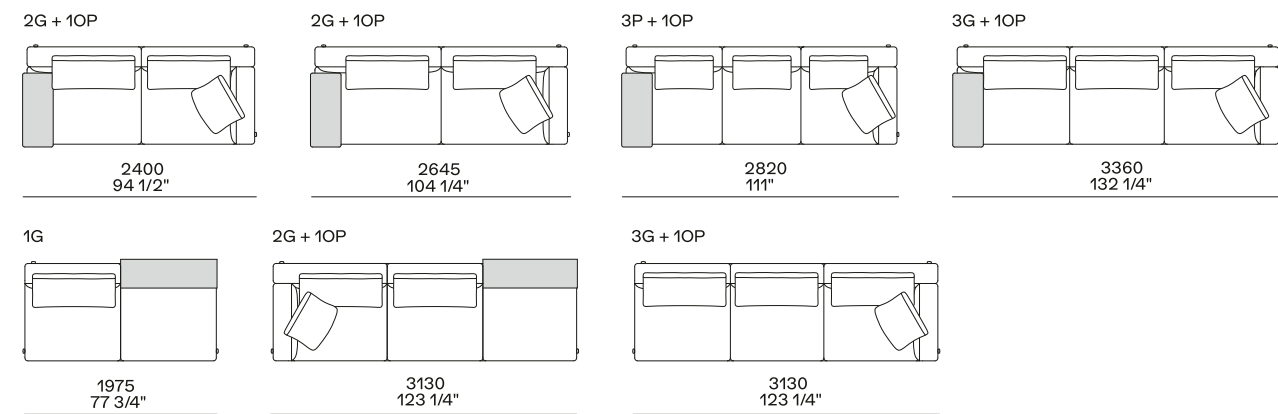

### Divano composto Modular sofa

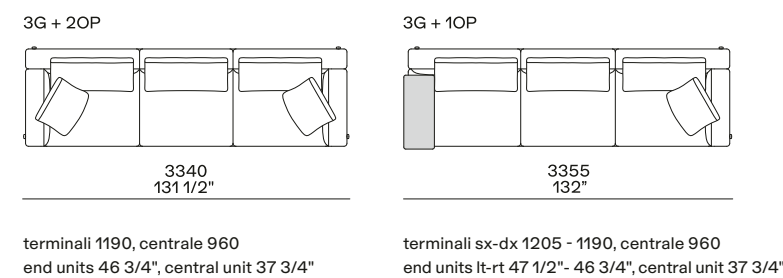

terminali 1190, centrale 960  
end units 46 3/4", central unit 37 3/4"

terminali sx-dx 1205 - 1190, centrale 960  
end units lt-rt 47 1/2" - 46 3/4", central unit 37 3/4"

### Chaise longue sx-dx Lt-rt chaise longue

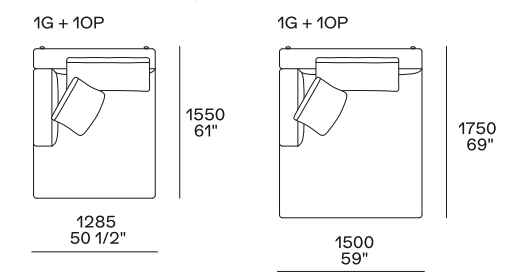

anche uso terminale  
also used as end unit

anche uso terminale  
also used as end unit

### Lounge chair sx-dx Lt-rt lounge chair

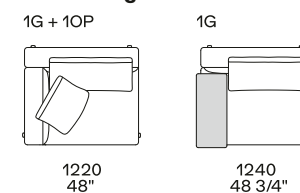

### Vassoio opzionale Optional tray

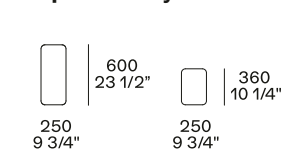

per utilizzo su bracciolo Slim o mensola  
to be used on Slim arm or shelf

#### NB

Divano privo di giunzioni, liberamente aggregabile. Sofa without joints, allowing combination freedom.

**Terminale sx-dx  
Lt-rt end unit**

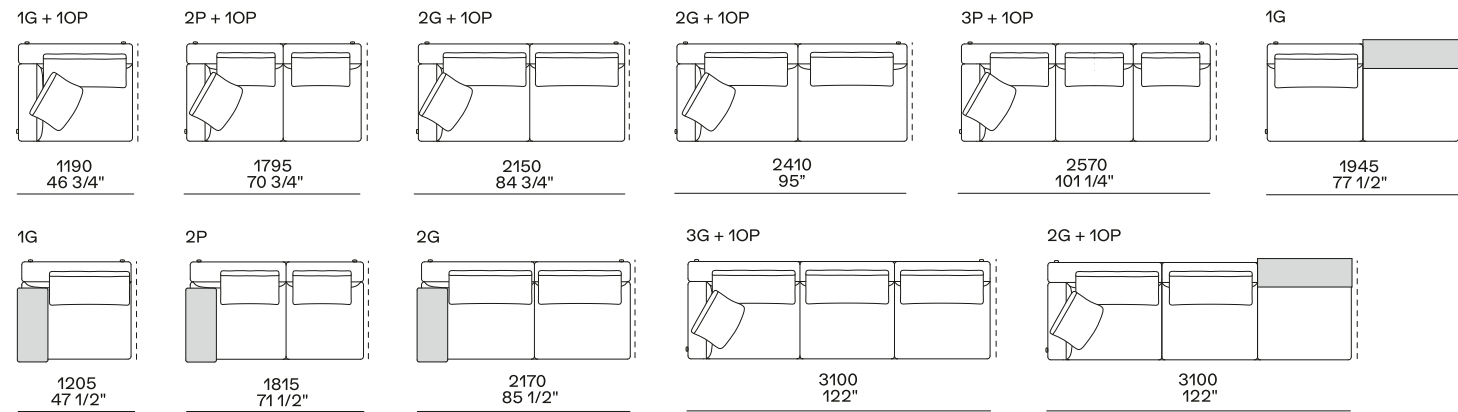

**Angolo sx-dx  
Lt-rt corner unit**

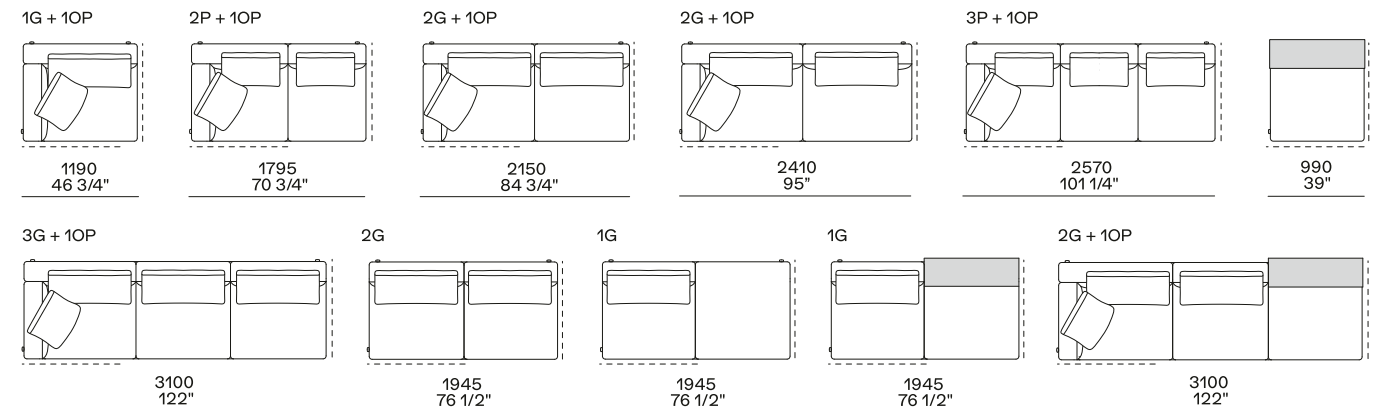

**Terminale senza bracciolo sx-dx  
Lt-rt end unit whitout arm**

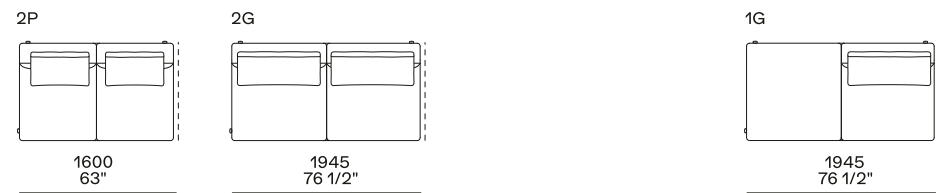

**Terminale penisola sx-dx  
Lt-rt peninsula end unit**

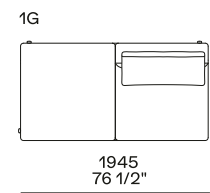

**Terminale inclinato sx-dx  
Lt-rt angled end-unit**

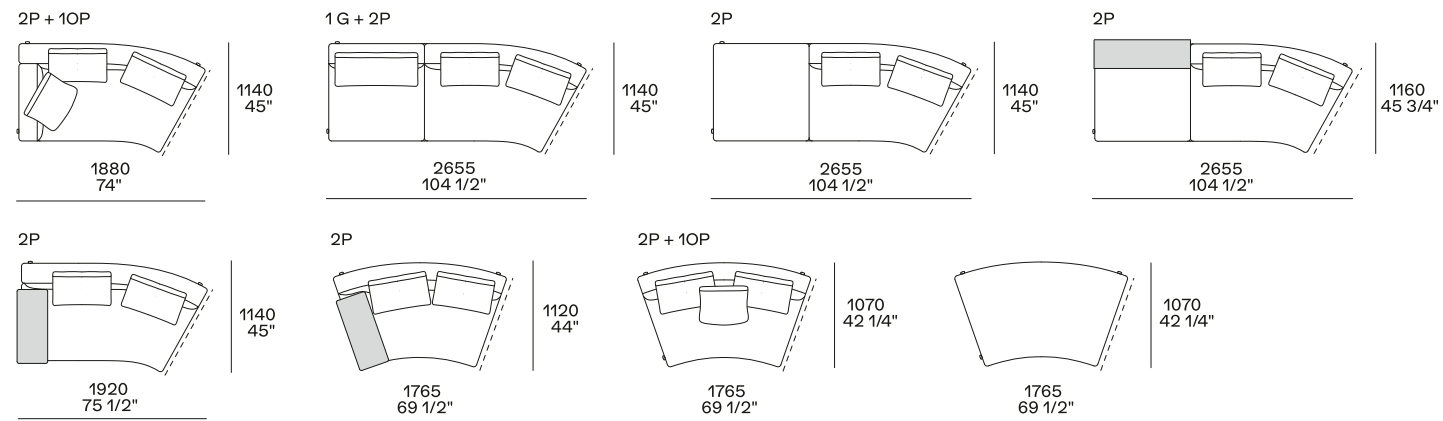

**Centrale  
Central unit**

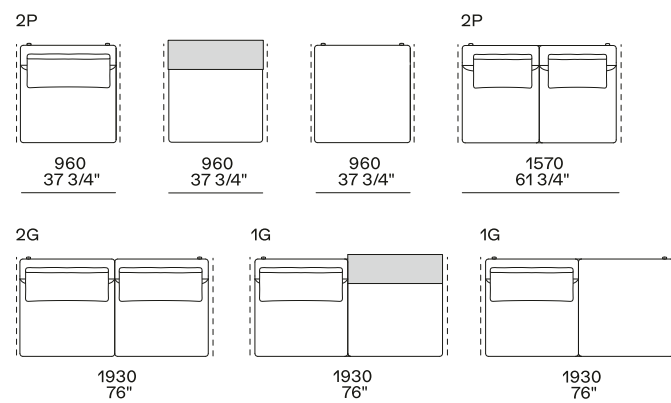

**Centrale inclinato  
Angled central unit**

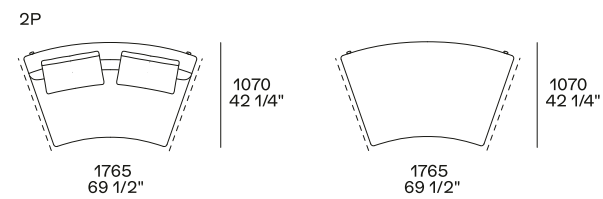

**Terminale angolare sx-dx  
Lt-rt corner end unit**

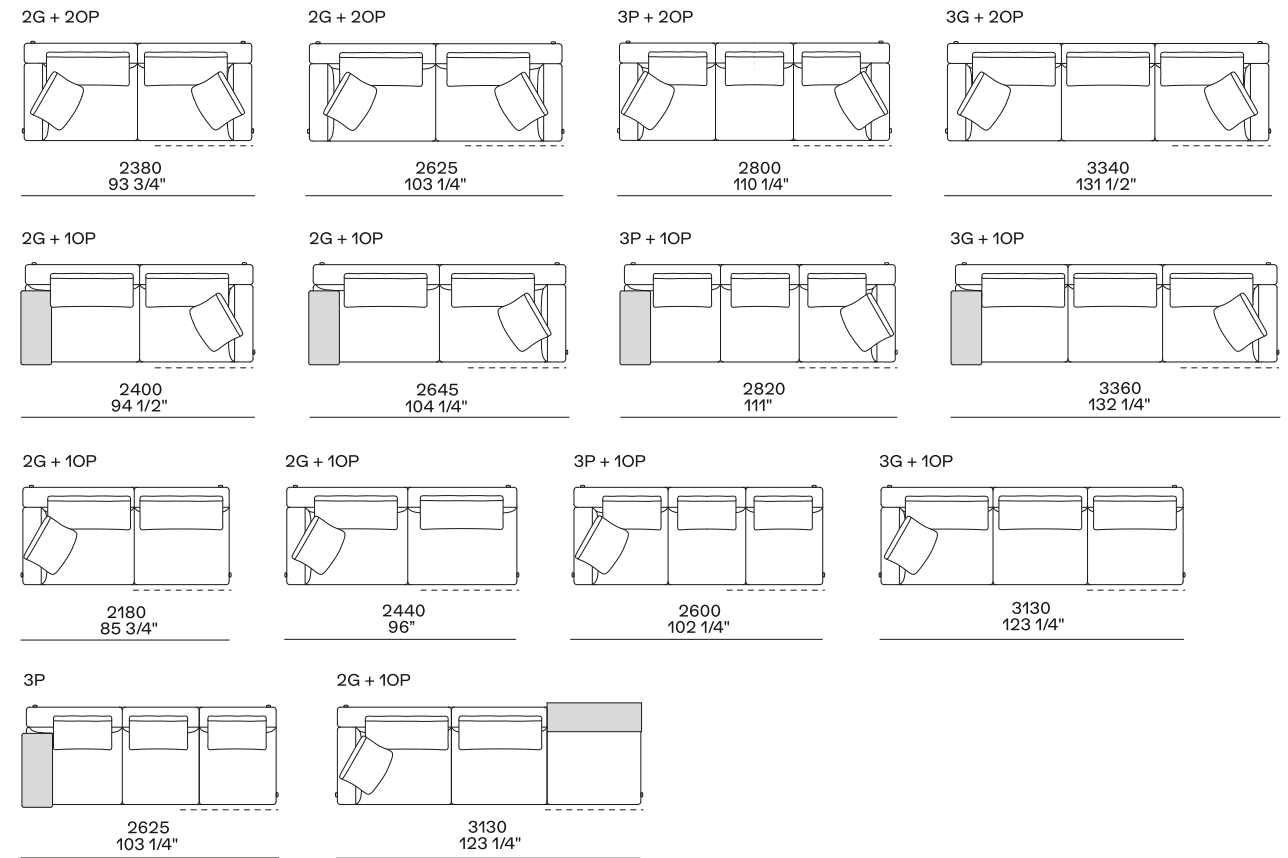

**Terminale angolare senza bracciolo sx-dx  
Lt-rt corner end unit whitout arm**

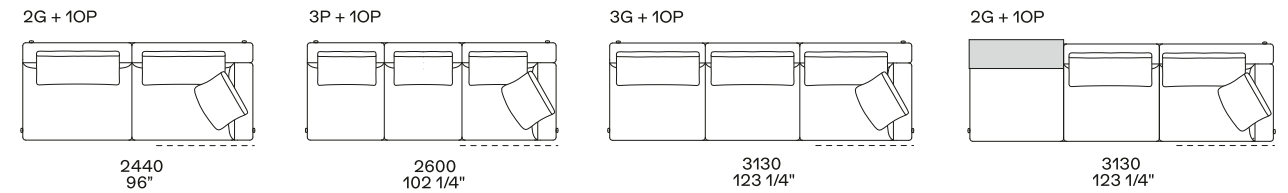

**NB**  
Divano privo di giunzioni, liberamente aggregabile.  
Sofa without joints, allowing combination freedom.



# MUSH

Mush è un sistema di tavolini dall'estetica essenziale, pensato per accompagnare con discrezione il divano Brera. Il piano è disponibile quadrato o rettangolare, sempre con angoli stondati, oppure circolare, in diverse altezze e dimensioni. Nella versione in olmo nero, lo spessore del piano è il frutto di una lavorazione artigianale eseguita a mano. Nella variante tonda e alta, ideale accanto al divano, il tavolino è disponibile anche completamente rivestito in cuoio.

Mush is a coffee table system with an essential aesthetic, designed as a discreet accompaniment to the Brera sofa. With a choice of a square or rectangular top with rounded corners or a round top, it comes in different heights and sizes. In the black elm version, the thickness of the tabletop is the result of hand crafting. The round and tall version of the coffee table, which is ideal for placing next to the Brera sofa, is also available completely covered in hide.

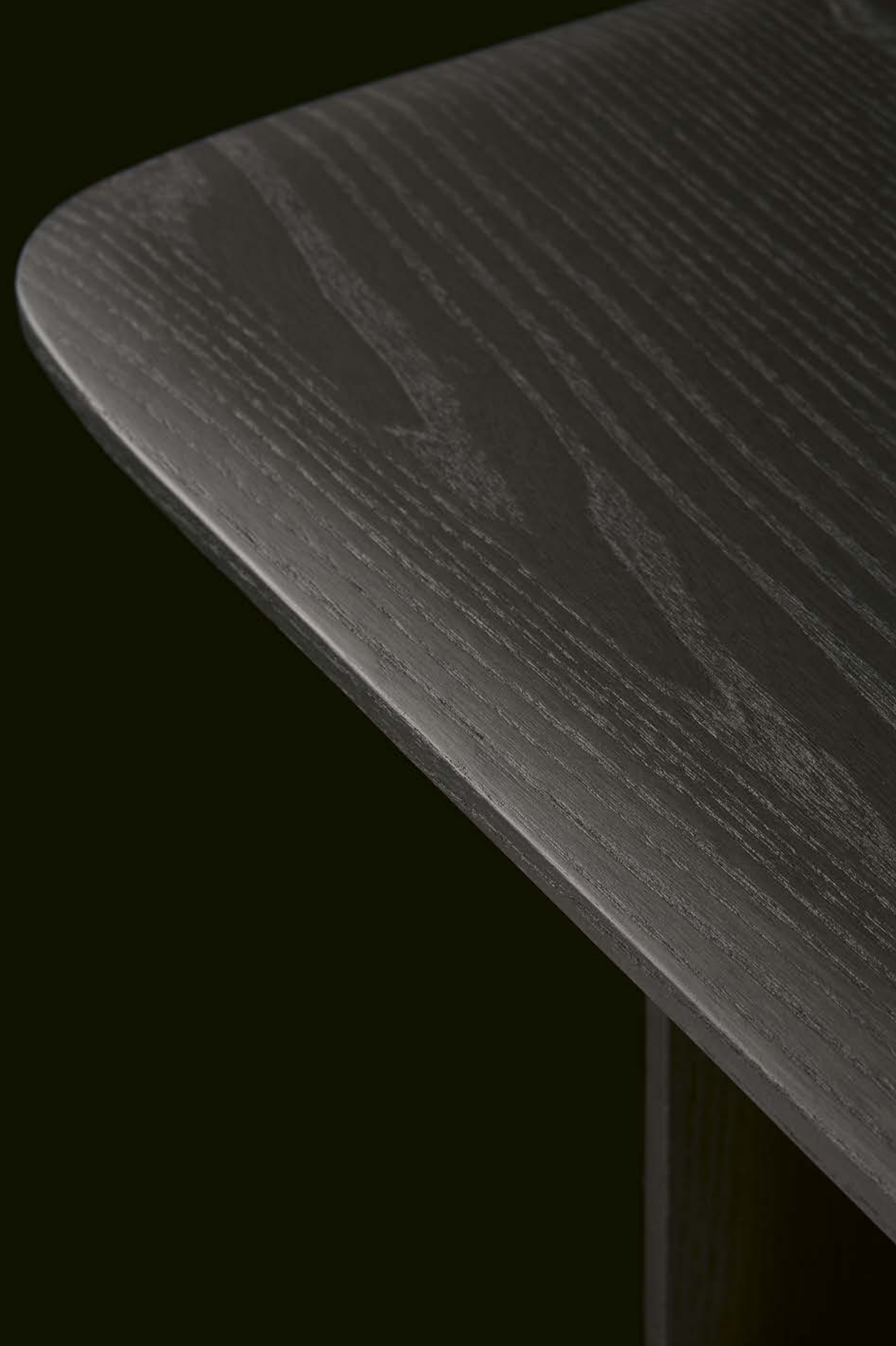





Nella pagina precedente: tavolini Mush con piani in olmo nero e in marmo verde lepanto lucido, strutture in olmo nero. In questa pagina: dettaglio del piano del tavolino Mush in marmo zecevo levigato, struttura in olmo nero. Nella pagina successiva: tavolini Mush con piani in olmo nero e in marmo sahara noir levigato finitura poliestere, struttura in olmo nero; accanto al divano piano e struttura in cuoio 07 castagna. Divani Brera con rivestimento sfoderabile in tessuto Kiala 02 champagne, cuscini in tessuto Janaki 01 avorio, basamento e bracciolo Slim in cuoio 07 castagna, piedini brown nickel opaco. Tappeto Plain natural.

Previous page: Mush coffee tables with black elm and glossy verde lepanto marble tops, black elm structures. This page: close up of the Mush coffee table-top in mat zecevo marble, structure in black elm. Next page: Mush coffee tables with black elm and mat sahara noir marble tops, polyester finish, black elm structure; next to the sofa, top and structure in hide 07 castagna. Brera sofas with removable cover in fabric Kiala 02 champagne, cushions in fabric Janaki 01 avorio, base and Slim armrest in hide 07 castagna, mat brown nickel feet. Plain carpet natural.







Nella pagina precedente: tavolini Mush con piani in olmo nero e in marmo zecevo levigato, strutture in olmo nero. A destra: tavolino Mush in cuoio 08 fango e vassoio opzionale in olmo nero. Nella pagina successiva: tavolini Mush con piani e struttura in olmo nero e nella versione completamente rivestita in cuoio 08 fango, disponibile solo per i tavolini alti.

Previous page: Mush coffee tables with black elm and mat zecevo marble tops, black elm structures. Right: Mush coffee table in hide 08 fango and optional tray in black elm. Next page: Mush coffee tables with tops and structure in black elm and in the version fully covered in hide 08 fango, available only for high tables.





## MUSH

Design Jean-Marie Massaud

Tavolini con struttura in olmo nero.  
Piano in olmo nero o marmo levigato e lucido (Ø 1400 escluso zecevo).  
Tavolini h 380-500 disponibili solo con struttura e piano in olmo nero o struttura e piano rivestiti in cuoio colori.  
Vassoio opzionale in olmo nero, a libero posizionamento.

Coffee tables with black elm structure.  
Top in black elm or mat and glossy marble (Ø 55" except zecevo).  
Coffee tables h 15"-19 3/4" available only with structure and top in black elm or structure and top covered in hide in the sample colours.  
Freestanding optional tray in black elm.

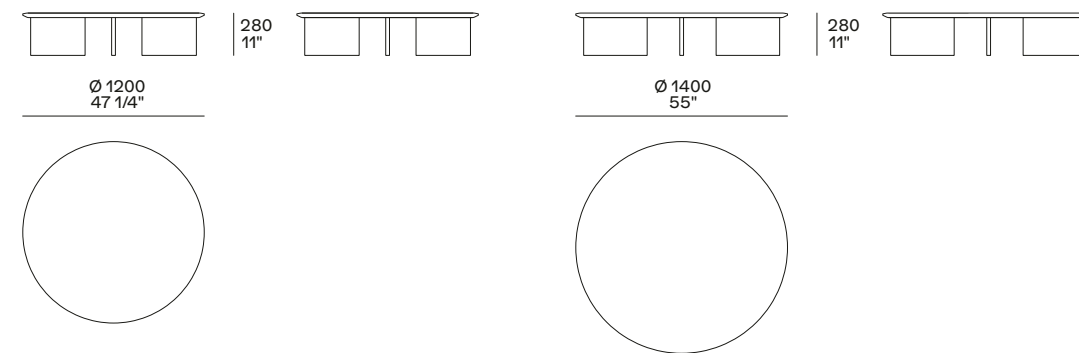
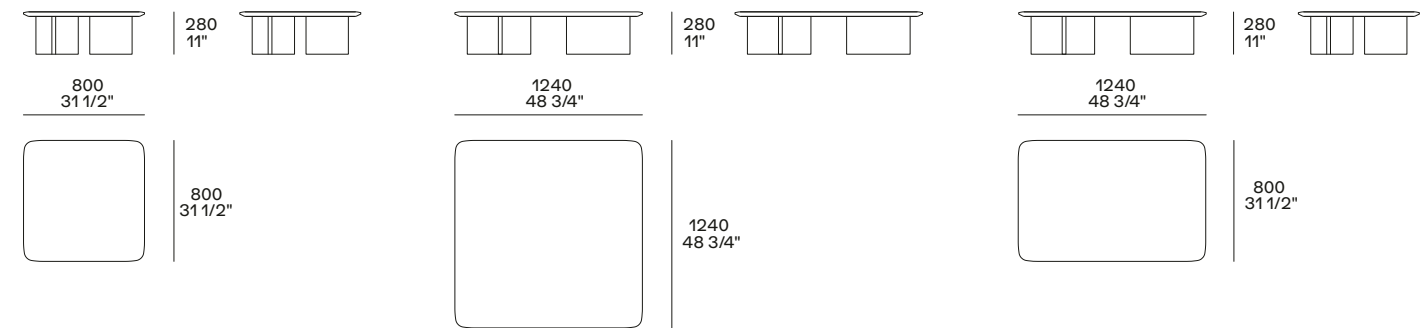

### Tavolini h 380-500 Coffee tables h 15"- 19 3/4"

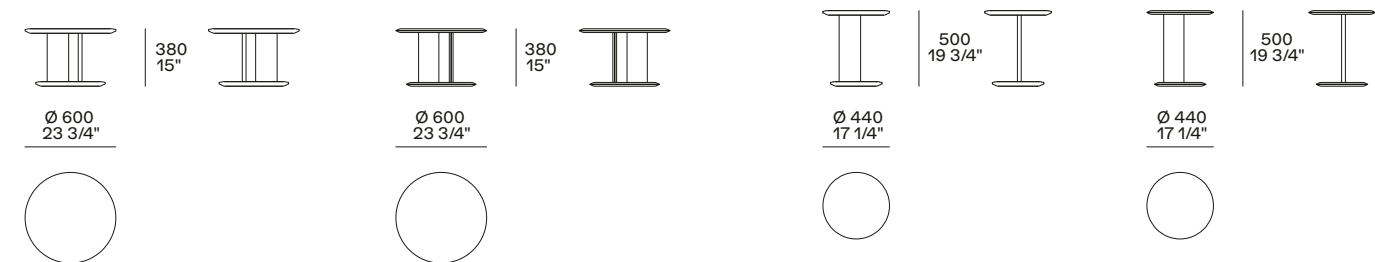

versione cuoio  
hide version

versione cuoio  
hide version

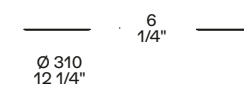

vassoio opzionale  
optional tray



# KAORI

A fare da contrappunto al divano Brera, e in generale a tutti i divani della collezione Sofas che abbiano una forte connotazione architettonica, è la poltrona Kaori, caratterizzata da linee morbide e volumi generosi. Elegante nelle linee, la poltrona è molto sofisticata, essendo costituita da due scocche perfettamente integrate – quella esterna in cuoio, quella interna morbidamente imbottita e rivestita in tessuto o pelle. Al comfort visivo corrisponde quello della seduta, studiata per la massima comodità.

The Kaori armchair is a counterpoint to the Brera sofa, as well as to all the designs in the Sofas collection that have a strong architectural connotation. It is characterised by soft lines and generous volumes. Elegant and sophisticated, the armchair is made up of two perfectly integrated shells – the outer one in hide, the inner one softly padded and upholstered in fabric or leather. Its visual appeal is matched by that of the seat, designed for maximum comfort.





Nella pagina precedente: poltrone Kaori con scocca esterna e basamento in cuoio 07 castagna, scocca interna e seduta in pelle sfoderabile Silk 10 terracotta, piedini brown nickel opaco. Poltrona Kaori con scocca esterna e basamento in cuoio 03 grigio scuro, scocca interna e seduta in tessuto sfoderabile Komi 09 argento, piedini brown nickel opaco. In questa pagina: poltrona Kaori con scocca esterna e basamento in cuoio 26 invecchiato, scocca interna e seduta in tessuto sfoderabile Naxos 16 sabbia, piedini brown nickel opaco. Tavolini Mush con piani in olmo nero e in marmo sahara noir levigato finitura poliesteri, struttura in olmo nero.

Previous page: Kaori armchairs with outer shell and base in hide 07 castagna, inner shell and seat in removable leather Silk 10 terracotta, mat brown nickel feet. Kaori armchair with outer shell and base in hide 03 grigio scuro, inner shell and seat in removable fabric Komi 09 argento, mat brown nickel feet. This page: Kaori armchair with outer shell and base in hide 26 invecchiato, inner shell and seat in removable fabric Naxos 16 sabbia, mat brown nickel feet. Mush coffee tables with black elm and mat Sahara noir marble tops, polyester finish, black elm structure.

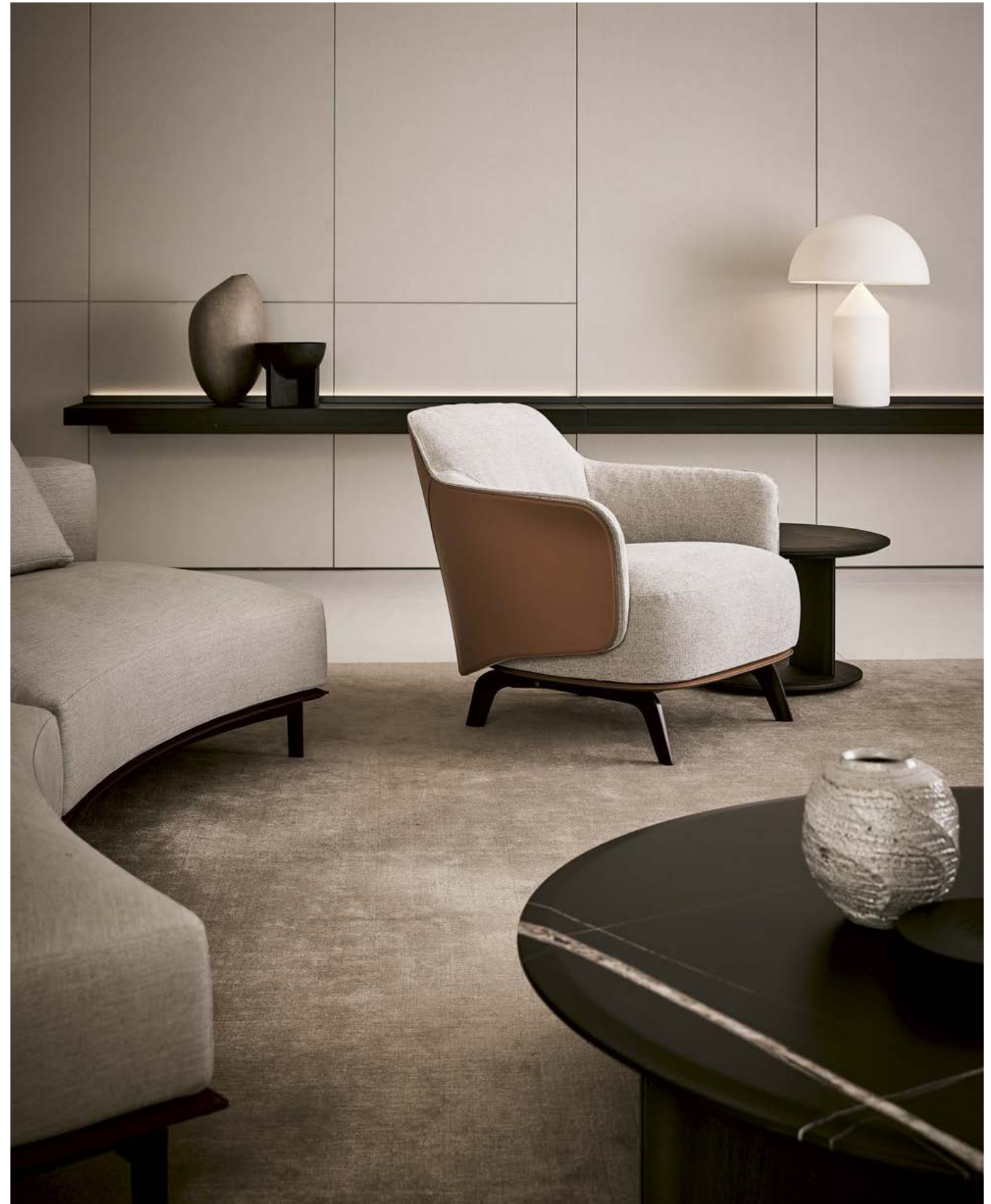





Nella pagina precedente: poltrone Kaori con scocca esterna e basamento in cuoio 07 castagna, scocca interna e seduta in pelle sfoderabile Silk 10 terracotta, piedini brown nickel opaco. Divano Brera, con rivestimento sfoderabile in tessuto Kiala 02 champagne, cuscini in tessuto Janaki 01 avorio, basamento e bracciolo Slim in cuoio 07 castagna, piedini brown nickel opaco. Tavolino Mush con piano in marmo sahara noir levigato finitura poliestere e struttura in olmo nero. Tappeto Plain natural. A destra: poltrona Kaori con scocca esterna e basamento in cuoio 03 grigio scuro, scocca interna e seduta in tessuto sfoderabile Komi 09 argento.

Previous page: Kaori armchairs with outer shell and base in hide 07 castagna, inner shell and seat in removable Silk 10 terracotta leather, mat brown nickel feet. Brera sofas with removable cover in Kiala 02 champagne fabric, pillows in Janaki 01 ivory fabric, base and Slim armrest in hide 07 castagna, mat brown nickel feet. Mush coffee table with mat sahara noir marble top, polyester finish and black elm structure. Plain carpet natural. Right: Kaori armchair with outer shell and base in hide 03 grigio scuro, inner shell and seat in removable fabric Komi 09 argento.





In questa pagina: poltrona Kaori con scocca esterna e basamento in cuoio 03 grigio scuro, scocca interna e seduta in tessuto sfoderabile Komi 09 argento, piedini brown nickel opaco.

This page: Kaori armchair with outer shell and base in hide 03 grigio scuro, inner shell and seat in removable fabric Komi 09 argento, mat brown nickel feet.

In questa pagina: poltrona Kaori con scocca esterna e basamento in cuoio 03 grigio scuro, scocca interna e seduta in tessuto sfoderabile Komi 09 argento, piedini brown nickel opaco. Nella successiva: poltrona Kaori con scocca esterna e basamento in cuoio 07 castagna, scocca interna e seduta in pelle sfoderabile Silk 10 terracotta, piedini brown nickel opaco.

This page: Kaori armchair with outer shell and base in hide 03 grigio scuro, inner shell and seat in removable fabric Komi 09 argento, mat brown nickel feet. Next page: Kaori armchair with outer shell and base in hide 07 castagna, inner shell and seat in removable leather Silk 10 terracotta, mat brown nickel feet.





## KAORI

Design Jean-Marie Massaud

Scocca in poliuretano compatto con inserto in poliuretano flessibile. Cuscino seduta in poliuretano flessibile a quote differenziate e prerivestimento parti in tela cotone con piuma. Basamento in legno e derivati rivestito in cuoio colori. Piedini in alluminio e struttura in acciaio verniciati brown nickel opaco e lucido o champagne opaco. Rivestimento scocca esterna non sfoderabile in cuoio colori, rivestimento scocca interna e seduta sfoderabile in tessuto o pelle.

Compact polyurethane shell with flexible polyurethane insert. Seat cushion in flexible polyurethane with differentiated densities and pre-cover with parts in cotton canvas with down. Wood and wood-derivatives base covered in hide in the sample colours. Aluminium feet and steel structure painted mat and glossy brown nickel or mat champagne. Non-removable outer shell cover in hide in the sample colours, inner shell and seat cover in removable fabric or leather.

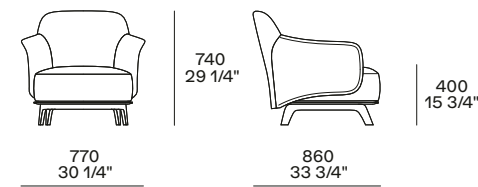

# CURVE

La poltrona Curve riprende le linee morbide e la centralità della materia legno dell'omonima collezione. L'intuizione di Emmanuel Gallina è stata quella di alleggerire struttura e imbottitura rendendole essenziali, senza rinunciare al comfort. Dettaglio funzionale ma di grande appeal è la maniglia curva dello schienale, che rende interessante il lato posteriore della poltrona. Disponibile in diverse finiture e in un'ampia gamma di rivestimenti, Curve può assumere l'estetica desiderata – più classica o più moderna.

The Curve armchair recalls the main features of the homonymous collection: soft lines and the centrality of wood. Emmanuel Gallina's intuition was to lighten structure and padding, stripping them down to their essence, without sacrificing comfort. The curved backrest handle is a visually enticing functional detail, lending the back of the armchair great appeal. Available in different finishes and a wide range of covers, Curve can take on the desired mood – from classic to more modern style.

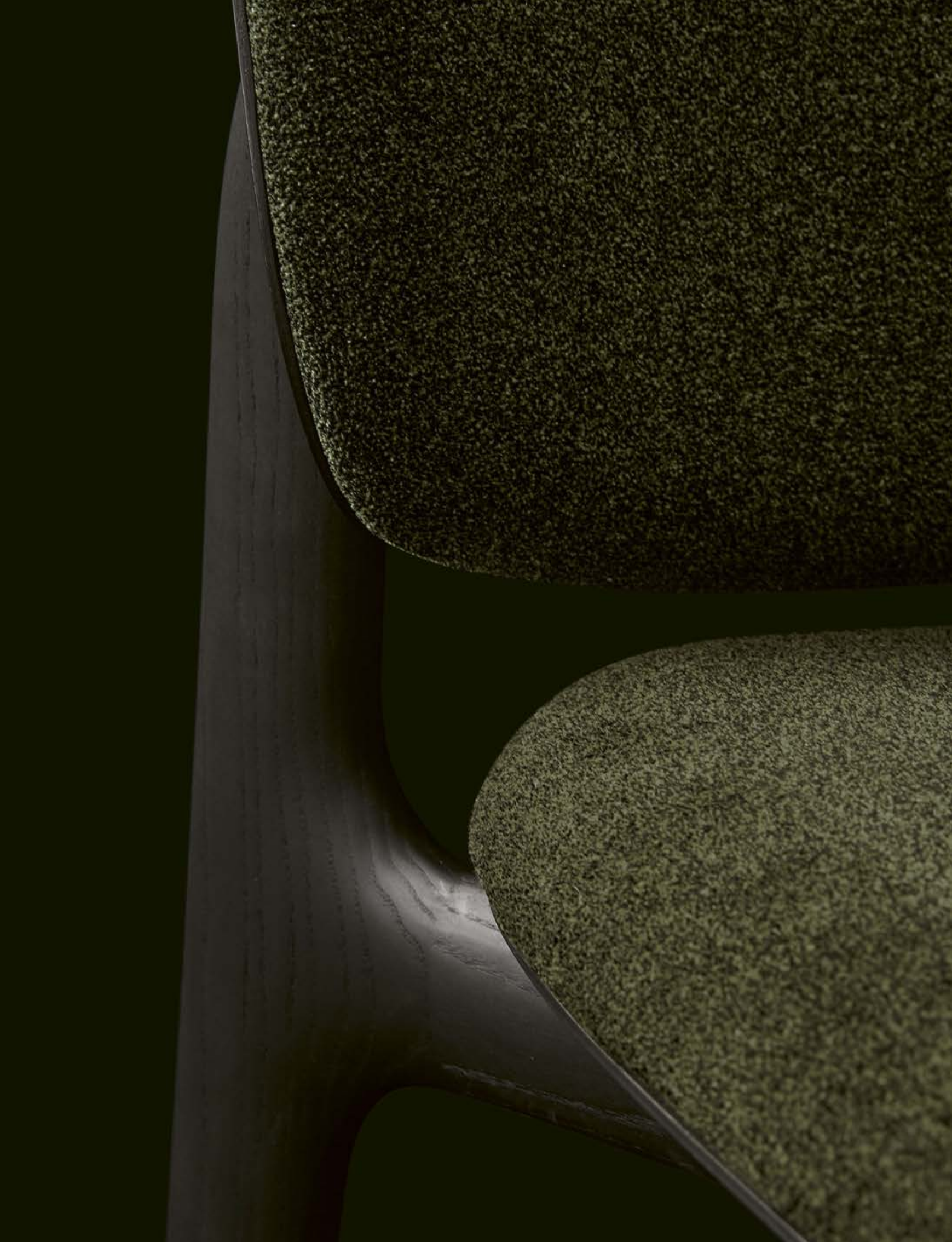



Nelle pagine introduttive: dettagli della poltrona Curve con struttura in olmo nero e rivestimento non sfoderabile in tessuto Agadir 08 foresta. Nella pagina precedente: poltrone Curve con struttura in olmo nero e rivestimento non sfoderabile in tessuto Agadir 08 foresta e in pelle Nabuk 03 cervo. A destra: dettaglio della poltrona Curve con struttura in olmo nero e rivestimento non sfoderabile in pelle Nabuk 03 cervo. Nella pagina successiva: poltrone e pouf Curve, struttura in olmo nero, rivestimento non sfoderabile in tessuto Siro 01 bianco. Divano Brera con rivestimento sfoderabile in tessuto Molai 04 creta, cuscini in tessuto Yushan 01 sabbia, basamento in cuoio 08 fango, piedini brown nickel opaco. Tavolini Mush con piano in olmo nero e in marmo zecevo levigato, struttura in olmo nero, tavolino rotondo con piano e struttura in cuoio 26 invecchiato. Paravento Hima con struttura in brown nickel opaco e corda nel colore cenere. Tappeto Shindo grey. In chiusura: poltrona e pouf Curve con struttura in olmo nero e rivestimento non sfoderabile in pelle Nabuk 03 cervo.

Introduction pages: close up of the Curve armchair with black elm structure and non-removable cover in fabric Agadir 08 foresta. Previous page: Curve armchairs with black elm structure and non-removable cover in fabric Agadir 08 foresta and leather Nabuk 03 cervo. Right: close up of the Curve armchair with black elm structure and non-removable cover in leather Nabuk 03 cervo. Next page: Curve armchairs and poufs, structure in black elm, non-removable cover in fabric Siro 01 bianco. Brera sofa with removable cover in fabric Molai 04 creta, cushions in fabric Yushan 01 sabbia, hide 08 fango base, mat brown nickel feet. Mush coffee tables, top in black elm and mat zecevo marble with structure in black elm, round top and structure in hide 26 invecchiato. Hima screen with structure in mat brown nickel and rope in the colour cenere. Shindo carpet grey. Closing page: Curve armchair and pouf with black elm structure and non-removable cover in leather Nabuk 03 cervo.

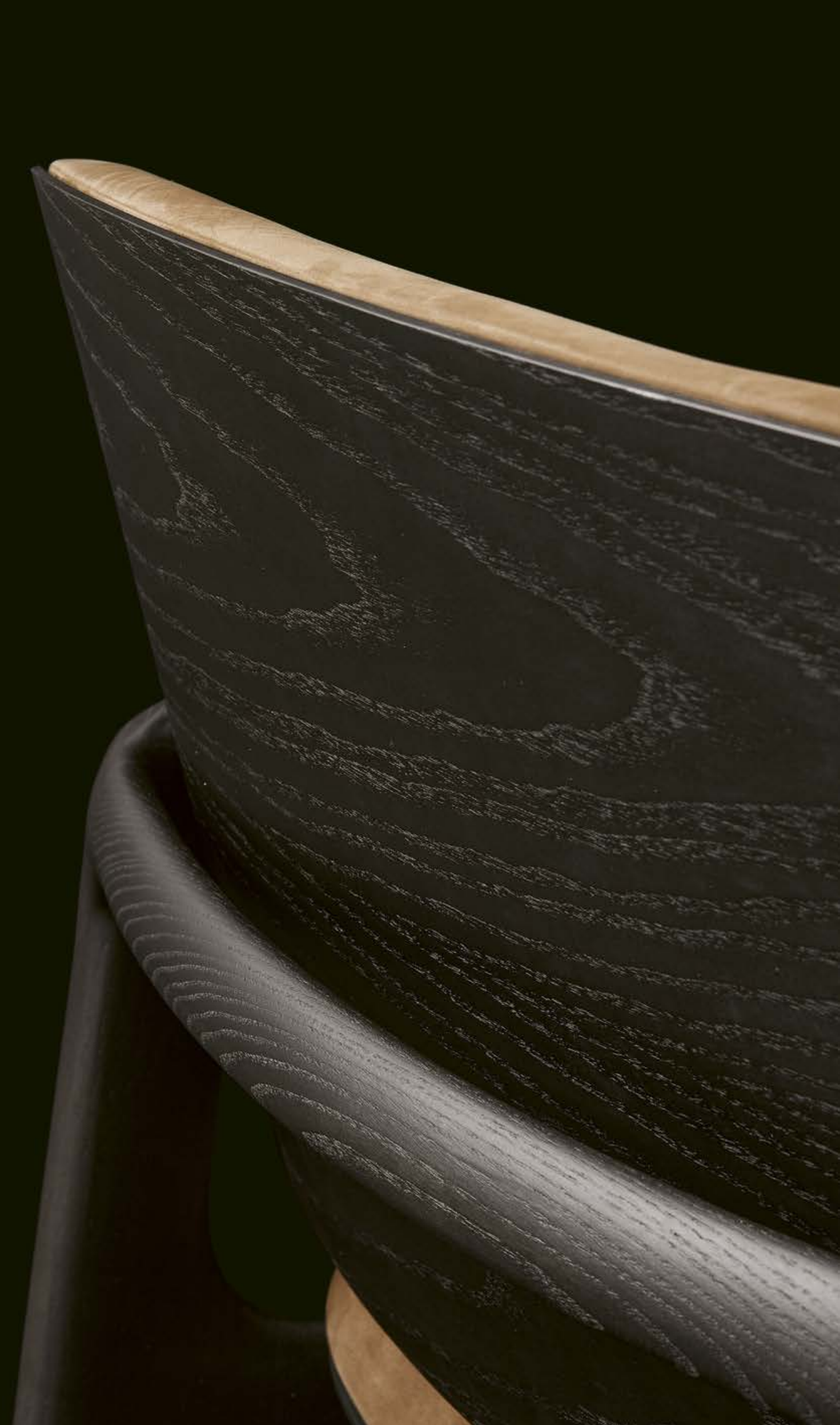







## CURVE

Design Emmanuel Gallina

Struttura in massello finitura rovere spessart o olmo nero.  
Seduta e schienale in poliuretano flessibile stampato, rivestimento non sfoderabile in tessuto o pelle.

Structure in solid wood spessart oak or black elm finish.  
Seat and back in moulded flexible polyurethane, non-removable cover in fabric or leather.

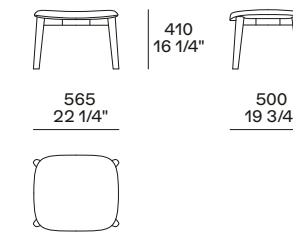
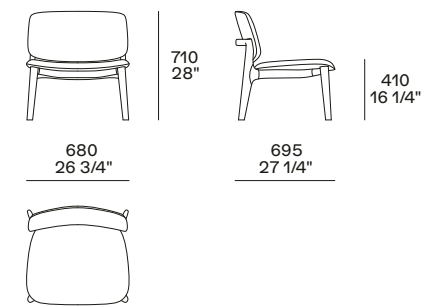

# UBE

Lo sgabello Ube è un elemento di rottura, un'opera d'arte prestata alla funzionalità del living. Ispirato al seme del coco de mer, frutto tropicale dalla forma suggestiva e sensuale, lo sgabello è caratterizzato dalla conformazione concava, che diventa una comoda culla su cui sedersi. Radicale anche nella realizzazione, è costituito da un blocco di legno massello, nella classica finitura olmo nero.

The Ube stool is an element of rupture, a work of art serving the functionality of the living area. Inspired by the seed of the coco de mer, a tropical fruit with an evocative and sensual shape, the stool has a distinctive concave shape, forming a comfortable cradle to sit on. Radical also in its realisation, it is made from a block of solid wood, in the classic black elm finish.



Qui, nelle pagine precedenti e nella successiva: sgabelli Ube in legno massello tinto olmo nero. Divano Brera con rivestimento sfoderabile in tessuto Kiala 02 champagne, cuscini in tessuto Janaki 01 avorio, basamento e bracciolo Slim in cuoio 07 castagna, piedini brown nickel opaco. Tavolini Mush, al centro piano in marmo sahara noir levigato finitura poliester e struttura in olmo nero; accanto al divano piano e struttura in cuoio 07 castagna. Tappeto Plain natural.

Here, previous and next pages: Ube stools in solid wood stained black elm. Brera sofa with removable cover in fabric Kiala 02 champagne, cushions in fabric Janaki 01 avorio, base and Slim armrest in hide 07 castagna, mat brown nickel feet. Mush coffee tables, in the centre, top in mat sahara noir marble with polyester finish and black elm structure; next to sofa, top and structure in hide 07 castagna. Plain carpet natural.





## UBE

Design Jean-Marie Massaud

Sgabello con struttura in legno massello,  
finitura tinto olmo nero.

Stool in solid wood structure, black elm  
stained finish.

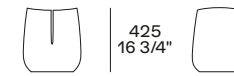

385  
15 1/4"





# NARA

La collezione Nara si amplia e accoglie due nuovi elementi: la panca e la consolle. Come il tavolino, di cui rappresentano la naturale evoluzione, sono realizzate in legno massello, con una lavorazione ispirata all'arte dell'ebanisteria. Panca e consolle sono complementi trasversali, per la zona notte o le aree d'ingresso, dove spiccano per la matericità solida ed elegante.

The Nara collection has been expanded to include two new elements: a bench and a console, which are the natural evolution of the coffee table by the same name. They too are made of solid wood, and crafted with a process inspired by the art of cabinet-making. The bench and console are versatile pieces: suitable for the bedroom or hallways, they stand out for their solid and elegant material quality.







Nella pagina precedente: consolle Nara in legno massello noce gold e tinto olmo nero, panca Nara in legno massello noce gold con cuscino opzionale, rivestimento sfoderabile in tessuto Molai 01 sabbia. A destra: consolle Nara in legno massello noce gold. Specchio Circle con cornice in cuoio 26 invecchiato e specchio bianco. Poltrona Curve con struttura in olmo nero e rivestimento non sfoderabile in tessuto Agadir 08 foresta. Tavolino Soori in metallo finitura bronzo anticato. Tappeto Plain natural.

Previous page: Nara console in solid wood gold walnut and stained black elm, Nara bench in solid wood gold walnut with optional cushion, removable cover in fabric Molai 01 sabbia. Right: Nara console table in solid wood gold walnut. Circle mirror, hide 26 invecchiato frame and white mirror. Curve armchair with black elm structure and non-removable cover in fabric Agadir 08 foresta. Soori coffee table in antique bronze-finish metal. Plain carpet natural.



Qui e nella pagina successiva: panca Nara in legno massello tinto olmo nero, cuscino opzionale con rivestimento sfoderabile in pelle Silk 12 senape.

Here and next page: Nara bench in solid wood stained black elm, optional cushion with cover in removable leather Silk 12 senape.





## NARA

Design Jean-Marie Massaud

Panca e consolle con struttura e piano in legno massello noce gold o tinto olmo nero. Cuscino opzionale per panca con rivestimento sfoderabile in tessuto o pelle.

Bench and console with structure and top in solid wood gold walnut or stained black elm. Optional bench cushion with removable cover in fabric or leather.

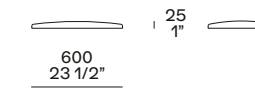
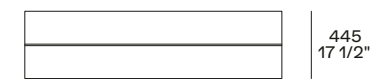
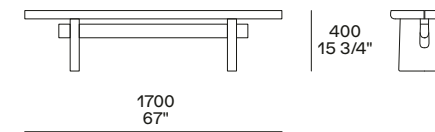

cuscino opzionale  
optional cushion

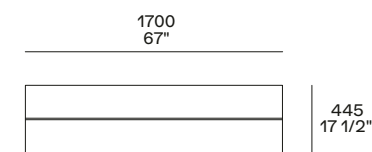
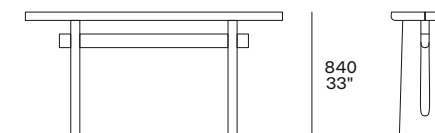



# HIMA

Essenziale, elegante e sensuale, il paravento è un complemento dal fascino antico eppure straordinariamente contemporaneo. Pur bidimensionale, è capace di creare uno spazio tridimensionale, come un elemento architettonico. Alle diverse altezze corrispondono diversi usi, da semplice séparé a protezione del divano, del letto o dell'angolo home office a vera e propria parete capace di creare uno spazio intimo e separato. Progettato da Jean-Marie Massaud, il paravento Hima si sposa alla perfezione con i prodotti della nuova collezione, in particolare con il divano Brera. Eleganti le finiture, in metallo verniciato e corda intrecciata.

Essential, elegant and sensual, the room divider is a piece with an antique yet extraordinarily contemporary charm. Although it is two-dimensional, it is capable of creating a three-dimensional space, as if it were an architectural element. Different heights lend themselves to different uses, from a simple screen to protect the sofa, bed or home office corner to a wall, capable of creating an intimate separate space. Designed by Jean-Marie Massaud, the Hima room divider is a perfect match for the products in the new collection, particularly the Brera sofa. It features elegant finishes in painted metal and woven rope.











In questa pagina: paravento Hima nella configurazione a quattro elementi ad altezza intermedia, struttura in brown nickel opaco e corda nel colore cenere. Nella pagina introduttiva: paraventi Hima nelle versioni alta e bassa, entrambi nella configurazione a quattro elementi, struttura in brown nickel opaco e corda nel colore cenere. Nella pagina precedente: paravento Hima nella versione bassa con struttura in brown nickel opaco e corda nel colore cenere. Divano Brera con rivestimento sfoderabile in tessuto Molai 04 creta, cuscini in tessuto Yushan 01 sabbia e in velluto Persia 1404 carbone, basamento e mensola in cuoio 08 fango, piedini brown nickel opaco. Tavolini Mush con piano in olmo nero e in marmo zecevo levigato, struttura in olmo nero. Poltrona Curve in olmo nero e tessuto non sfoderabile Siro 01 bianco. Tappeto Shindo grey.

This page: Hima screen in four-element configuration, intermediate height, structure in mat brown nickel and rope in the colour cenere. Introduction page: Hima screens in the high and low versions, both in four-element configuration, mat brown nickel structure and rope in the colour cenere. Previous page: Hima screen in the low version with structure in mat brown nickel and rope in the colour cenere. Brera sofa with removable cover in fabric Molai 04 creta, cushions in fabric Yushan 01 sabbia and velvet Persia 1404 carbone, base and shelf in hide 08 fango, mat brown nickel feet. Mush coffee tables with top in black elm and mat Zecevo marble, structure in black elm. Curve armchair in black elm and non-removable fabric Siro 01 bianco. Shindo carpet grey.

# HIMA

Design Jean-Marie Massaud

Paravento con struttura in metallo verniciato brown nickel opaco e corda colore cenere.

Paraventi pieghevoli, liberamente configurabili, da tre a cinque elementi disponibili in tre altezze, da sei elementi disponibili in due altezze.

Screen with structure in painted mat brown nickel metal and rope in the colour cenere.

Folding screens, freely configurable, with three to five elements available in three heights, with six elements available in two heights.

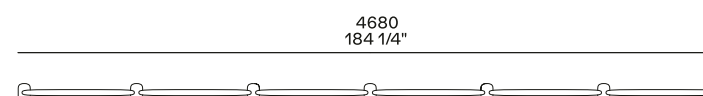
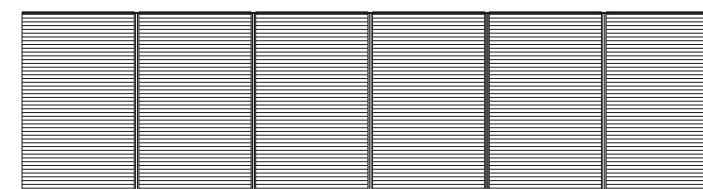
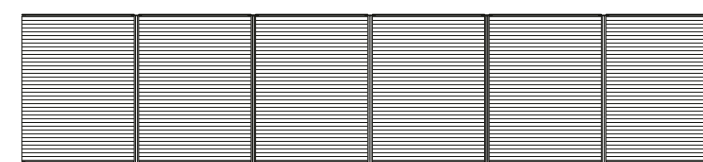
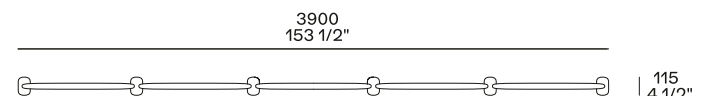
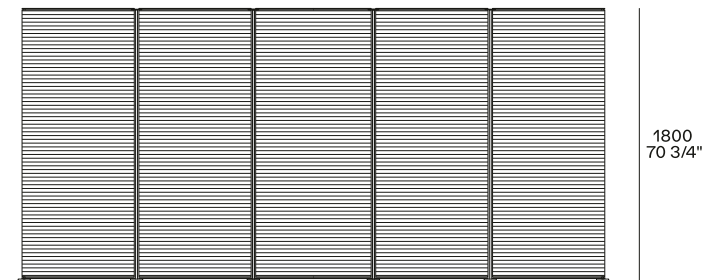
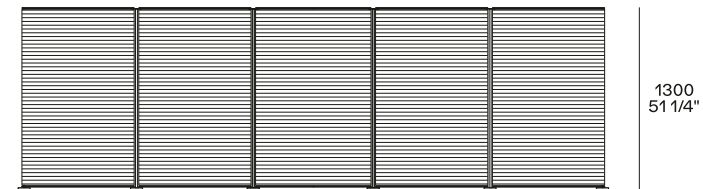
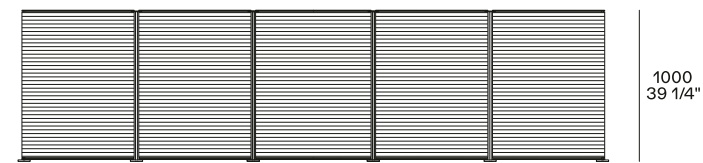
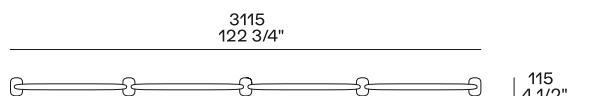
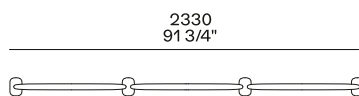
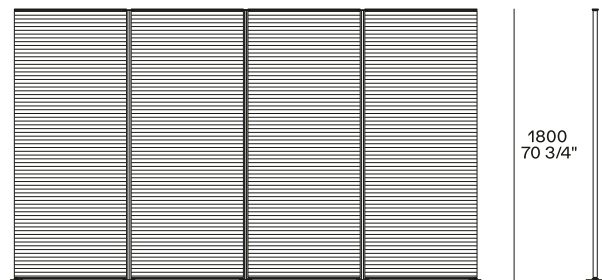
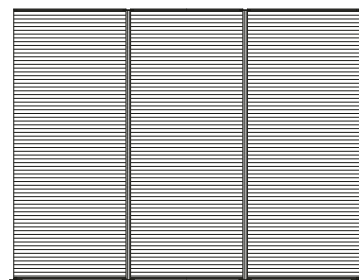
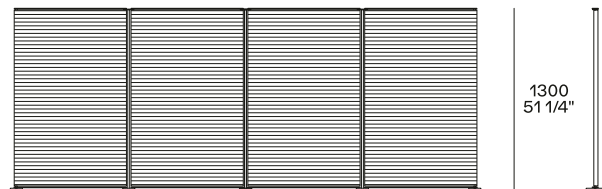
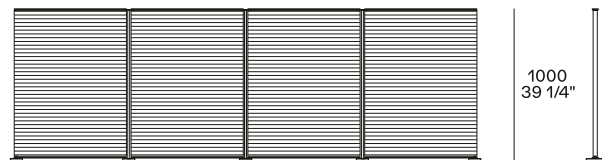
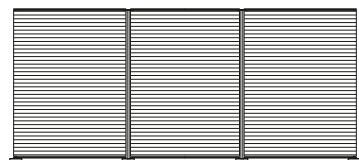

# AIKO

Aiko è un sistema di madie dalle linee essenziali e dai dettagli sofisticati. L'intuizione di Jean-Marie Massaud ha dato vita a un progetto che è un vero compendio del sapere aziendale. Ispirate alle antiche credenze, le madie sono sospese su un basamento con piedini, tutt'uno con le ante dai profili sagomati. L'attenzione al dettaglio è massima: dai ripiani che sembrano galleggiare all'interno del volume grazie ai reggipiani integrati all'illuminazione dall'allure sofisticata; dal piede centrale che diventa peculiarità estetica alla cerniera sviluppata ad hoc, cui corrisponde una preziosa placchetta metallica esterna. Particolari anche le finiture delle ante: oltre alla classica essenza, si aggiungono l'essenza effetto midollino e il vetro stratificato con interno in tessuto effetto lino.

Aiko is a system of sideboards with clean lines and sophisticated details. Jean-Marie Massaud's intuition has given life to a project that is a true compendium of Poliform's know-how. Inspired by ancient cupboards, the sideboards are suspended on a base with feet, in line with the doors with shaped profiles. Attention to detail is key: from shelves that appear to be floating inside the volume thanks to the integrated shelf supports to the sophisticated lighting; from the central foot that becomes an aesthetic feature to the hinge, developed ad hoc, that ends in a precious external metal plaque. The door finishes are also outstanding: in addition to the classic wood, there is a wicker-effect wood and a laminated glass version with a linen-effect fabric interior.





Nelle pagine introduttive: madia Aiko, dettagli dell'anta con cerniera incassata nel profilo laterale e delle maniglie incassate nel profilo superiore, cerniere e maniglie in brown nickel opaco. Nella precedente: madie Aiko con struttura in olmo nero, fianchi, schienali e ante in vetro stratificato con inserto in lino carbone, basamento con piedini brown nickel opaco. Ripiani interni in vetro fumé, cassettiera interna in olmo nero. In questa pagina: madia Aiko con struttura e schienali in olmo nero, fianchi e ante in vetro stratificato con inserto in lino carbone, basamento con piedini brown nickel opaco, ripiani interni in vetro fumé. Tavolo Curve con piano in marmo verde lepanto levigato e struttura in olmo nero. Sedia Curve con braccioli, struttura in olmo nero, schienale e seduta in tessuto non sfoderabile Brest 02 salvia. Tappeto Frame carbone. Nella successiva: madia Aiko con struttura e schienali in olmo nero, fianchi e ante in vetro stratificato con inserto in lino carbone, basamento con piedini brown nickel opaco, ripiani interni in vetro fumé. Poltrona Kaori con scocca esterna e basamento in cuoio 26 invecchiato, scocca interna e seduta in tessuto sfoderabile Naxos 16 sabbia, piedini brown nickel opaco. Tavolino Soori in metallo finitura bronzo anticato. Tavolino Mush in cuoio 26 invecchiato. Tappeto Shindo celadon.

Introduction pages: Aiko sideboard, close up of the leaf door recessed hinge in the side profile and the handles recessed in the upper profile, hinges and handles in mat brown nickel. Previous page: Aiko sideboards with black elm structure, sides, backs and doors in stratified glass with lino carbone insert, base with mat brown nickel feet. Internal shelves in fume glass, internal drawers in black elm. This page: Aiko sideboard with structure and backs in black elm, sides and doors in stratified glass with lino carbone insert, base with mat brown nickel feet, internal shelves in fume glass. Curve table with mat verde lepanto marble top and black elm structure. Curve chair with armrests, structure in black elm, backrest and seat in non-removable fabric Brest 02 salvia. Frame carpet carbone. Next page: Aiko sideboard with structure and backs in black elm, sides and doors in stratified glass with lino carbone insert, base with mat brown nickel feet, internal shelves in fume glass. Kaori armchair with outer shell and base in hide 26 invecchiato, inner shell and seat in removable fabric Naxos 16 sabbia, mat brown nickel feet. Soori coffee table in antique bronze-finish metal. Mush coffee table in hide 26 invecchiato. Shindo carpet celadon.







Qui e nella pagina successiva: madia Aiko con struttura e schienali in olmo nero, ante e fianchi in midollino finitura olmo nero, basamento con piedini brown nickel opaco.

Here and next page: Aiko sideboard with structure and backs in black elm, wicker doors and sides in black elm finish, base with mat brown nickel feet.





In questa pagina: dettaglio del profilo sagomato dell'anta e del basamento con piedino. Anta in midollino finitura olmo nero con profilo in olmo nero, basamento con piedino in brown nickel opaco.

This page: close up of the shaped profile of door and base with foot. Door in wicker with black elm finish with black elm profile, base with foot in mat brown nickel.





In questa pagina: madia Aiko con struttura, fianchi e schienali in olmo nero, ante in midollino finitura olmo nero, basamento con piedini brown nickel opaco.

This page: Aiko sideboard with structure, sides and backs in black elm, wicker doors in black elm finish, base with mat brown nickel feet.

# AIKO

Design Jean-Marie Massaud

Serie di madie con ante battenti, disponibili in cinque configurazioni e in due altezze di piedini. Struttura in olmo nero.

Schienali in olmo nero, vetro fumé, vetro trasparente o in vetro stratificato con inserto in lino carbone.

Fianchi e ante in olmo nero, vetro fumé, vetro trasparente, vetro stratificato con inserto in lino carbone o in midollino finitura olmo nero. Maniglie in brown nickel opaco, incassate nel profilo superiore delle ante.

Basamento con piedini in metallo verniciato brown nickel opaco. Luce a led.

Attrezzature: ripiani in vetro fumé, cassetteria in olmo nero solo per madie alte.

Series of sideboards with leaf doors, available in five configurations and with two heights of the feet. Structure in black elm.

Backs in black elm, fume glass, transparent glass or stratified glass with insert in lino carbone.

Sides and doors in black elm, fume glass, transparent glass, stratified glass with insert in lino carbone or in wicker in black elm finishing. Handles in matt brown nickel, built-in in the upper door profile.

Base with feet in matt brown nickel painted metal. Led light.

Equipment: shelves in fume glass, chest of drawers in black elm, only for high sideboards.

## Madie con piedini h 240 Sideboards with feet h 9 1/2"

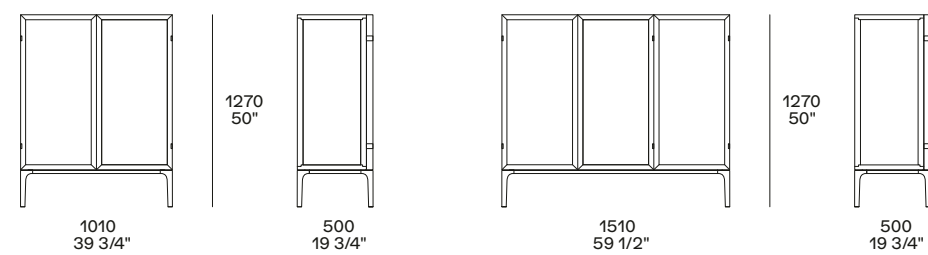
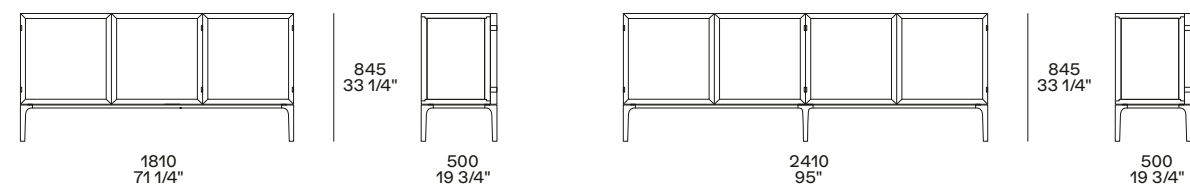
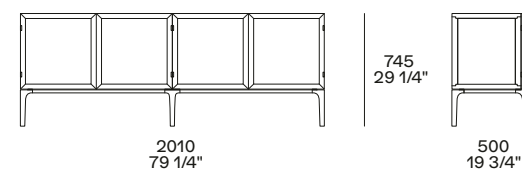

## Madie con piedini h 360 Sideboards with feet h 14 1/4"

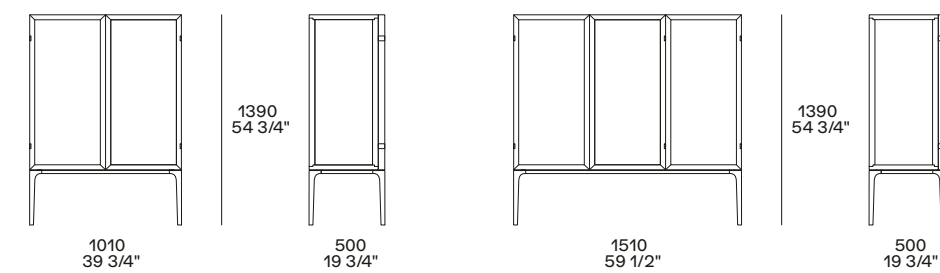
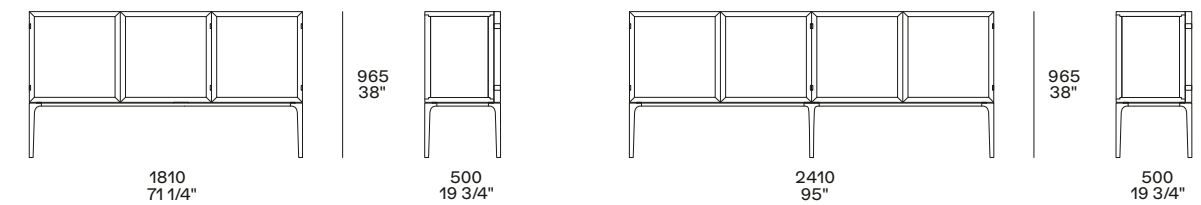
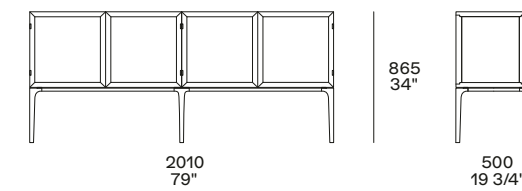

# CURVE

Curve è un tavolo essenziale e solido, dove s'incontrano linee gentili e dettagli di grande forza visiva come il traverso in legno. Parte della più ampia collezione Curve disegnata da Emmanuel Gallina, il tavolo è disponibile con struttura in essenza e piano in marmo o in essenza con bordo lavorato artigianalmente. Elemento di grande forza espressiva, il traverso può essere rivestito in cuoio.

Curve is an essential and solid table, where gentle lines meet visually striking details, such as the wooden crosspiece. Part of the Curve collection designed by Emmanuel Gallina, the table is available with a wood structure and marble or wood top with a delicately handcrafted edge. The crosspiece, a greatly expressive element, can be covered in hide.









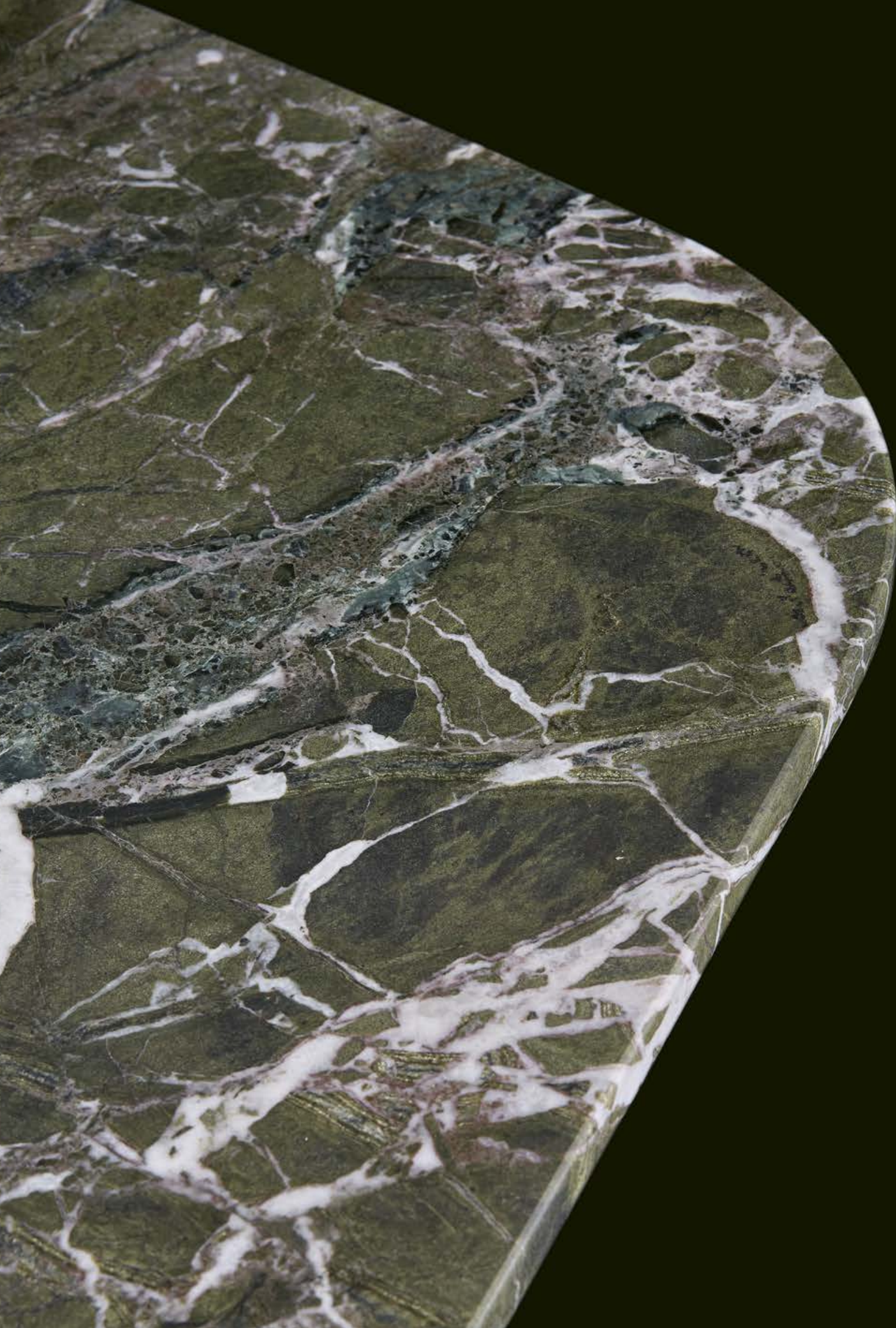

Nelle pagine introduttive: tavolo Curve con piano e struttura in olmo nero, traverso rivestito in cuoio 38 oliva. Qui e nella pagina precedente: tavolo Curve con piano in marmo verde lepanto levigato e struttura in olmo nero, traverso rivestito in cuoio 38 oliva. Sedie Curve con braccioli, struttura in olmo nero, seduta e schienale in tessuto non sfoderabile Brest 02 salvia. Madia Aiko con struttura e schienali in olmo nero, fianchi e ante in vetro stratificato con inserto in lino carbone, basamento con piedini brown nickel opaco, ripiani interni in vetro fumé. Tappeto Frame carbone.

Introduction pages: Curve table with top and structure in black elm, crosspiece covered in hide 38 oliva. Here and previous page: Curve table with mat verde lepanto marble top and black elm structure, 38 oliva hide covered crosspiece. Curve chairs with armrests, structure in black elm, seat and back in non-removable fabric Brest 02 salvia. Aiko sideboard with structure and backs in black elm, sides and doors in stratified glass with lino carbone insert, base with mat brown nickel feet, internal shelves in fume glass. Frame carpet carbone.



Nella pagina precedente: tavolo Curve con piano in marmo verde lepanto levigato e struttura in olmo nero. A destra: dettaglio della struttura del tavolo Curve con traverso in olmo nero. Nella pagina successiva: tavolo Curve con piano e struttura in olmo nero, traverso rivestito in cuoio 38 oliva.

Previous page: Curve table with mat verde lepanto marble top and black elm structure. Right: close up of the Curve table structure with black elm crosspiece. Next page: Curve table with top and structure in black elm, crosspiece covered in hide 38 oliva.





## CURVE

Design Emmanuel Gallina

Struttura in massello finitura rovere spessart o olmo nero, traverso in massello nelle stesse finiture della struttura o in alluminio rivestito in cuoio colori. Piano in rovere spessart, olmo nero o marmo levigato e lucido (escluso zecevo).

Structure in solid wood spessart oak or black elm finish, solid crosspiece in the same finishes as the structure or in aluminium covered in hide in the sample colours. Top in spessart oak, black elm or mat and glossy marble (except zecevo).

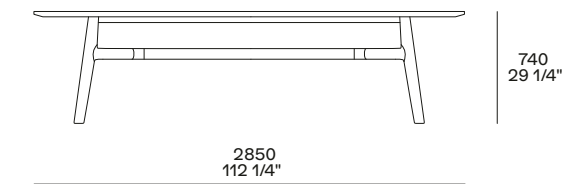
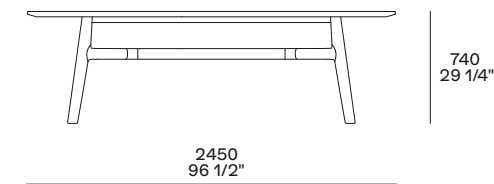
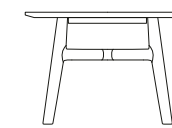
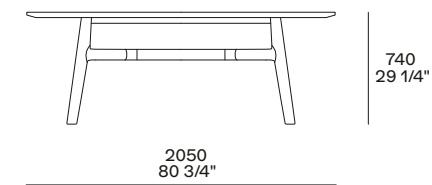

# CURVE



Una sedia leggera ed elegante, che dietro l'apparente semplicità nasconde un'accurata lavorazione del legno massello. Nelle tre varianti – tutto legno, legno con sedile imbottito e legno con sedile e schienale imbottiti – il materiale è protagonista. Curve morbide e assottigliamenti ne slanciano le linee, ispirate al design moderno. Il risultato è una sedia classica eppure contemporanea, ideale abbinata all'omonimo tavolo.

Light and elegant, behind its apparent simplicity this chair hides an intricate crafting of solid wood. In all three variants – wood, wood with upholstered seat and wood with upholstered seat and backrest – the material is the protagonist. Soft curves and tapering slender lines are inspired by modern design. The result is a classic yet contemporary chair, ideally combined with the table by the same name.





Nella pagina precedente: sedie Curve con struttura in olmo nero, nella versione senza braccioli con seduta e schienale in olmo nero e in tessuto non sfoderabile Micene 04 corda, nella versione con braccioli con seduta e schienale in tessuto non sfoderabile Micene 04 corda e in pelle non sfoderabile Soft 04 cognac. In questa pagina: sedie Curve con braccioli, struttura in olmo nero, seduta e schienale in tessuto non sfoderabile Brest 02 salvia. Tavolo Curve con piano in marmo verde lepanto levigato e struttura in olmo nero, traverso rivestito in cuoio 38 oliva. Tappeto Frame carbone.

Previous page: Curve chairs with structure in black elm, in the version without armrests with seat and back in black elm and in non-removable fabric Micene 04 corda, in the armrest version with seat and back in non-removable fabric Micene 04 corda and non-removable leather Soft 04 cognac. This page: Curve chairs with armrests, structure in black elm, seat and back in non-removable fabric Brest 02 salvia. Curve table with mat verde lepanto marble top and black elm structure, 38 oliva hide-covered crosspiece. Frame carpet carbone.







In questa pagina: sedia Curve con braccioli, struttura e schienale in olmo nero, seduta in pelle non sfoderabile Soft 07 roccia.

This page: Curve chair with armrests, structure and back in black elm, seat in non-removable leather Soft 07 roccia.

In questa pagina: dettaglio della sedia Curve con braccioli, struttura in olmo nero, seduta e schienale in olmo nero.

This page: close up of the Curve chair with armrests, black elm structure, seat and back in black elm.





In questa pagina: sedie Curve con braccioli, struttura in olmo nero, nelle versioni con seduta e schienale in tessuto non sfoderabile Micene 04 corda e con seduta e schienale in olmo nero.

This page: Curve chairs with armrests, structure in black elm, in versions with seat and back in non-removable fabric Micene 04 corda and with seat and back in black elm.

In questa pagina: dettaglio della sedia Curve con braccioli, struttura in olmo nero, seduta e schienale in tessuto non sfoderabile Micene 04 corda.

This page: close up of the Curve chair with armrests, black elm structure, seat and backrest in non-removable fabric Micene 04 corda.





In questa pagina: sedie Curve senza braccioli, struttura in olmo nero, seduta e schienale in pelle non sfoderabile Soft 04 cognac. Tavolo Curve con piano in marmo verde lepanto levigato e struttura in olmo nero. Tappeto Frame carbone. Nella pagina successiva: sedie Curve senza braccioli, struttura in olmo nero, nelle versioni con seduta in tessuto non sfoderabile Norwich 06 polvere e schienale in olmo nero e con seduta e schienale in pelle non sfoderabile Soft 09 bulgaro.

This page: Curve chairs without armrests, structure in black elm, seat and back in non-removable leather Soft 04 cognac. Curve table with mat verde lepanto marble top and black elm structure. Frame carpet carbone. Next page: Curve chairs without armrests, structure in black elm, in versions with seat in non-removable fabric Norwich 06 polvere and back in black elm and with seat and back in non-removable leather Soft 09 bulgaro.



## CURVE

Design Emmanuel Gallina

Struttura in massello finitura rovere spessart o olmo nero.

Seduta e schienale in legno curvato nelle stesse finiture della struttura o nella versione imbottita, imbottitura in poliuretano compatto, con inserto in poliuretano flessibile. Rivestimento non sfoderabile in tessuto o pelle.

Solid structure, spessart oak or black elm finish.

Seat and back in curved wood in the same finishes as the structure or in the padded version, padding in compact polyurethane, with flexible polyurethane insert. Non-removable cover in fabric or leather.

### Seduta e schienale legno Seat and backrest in wood

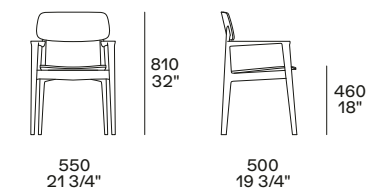
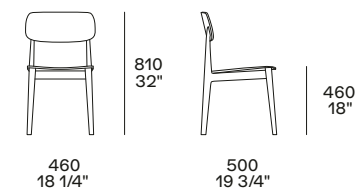

### Seduta e schienale imbottiti Padded seat and backrest

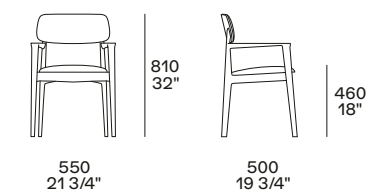
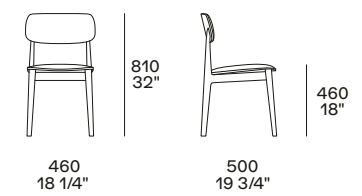

### Seduta imbottita e schienale legno Padded seat and backrest in wood

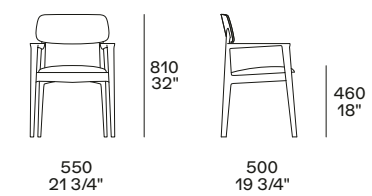
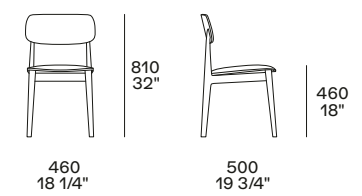



# YUME

Yume è un letto imbottito che reinterpreta un'estetica classica alla luce di una leggerezza sia visiva sia dei materiali, grazie alla testata morbida. Disegnato da Jean-Marie Massaud, unisce all'eleganza senza tempo la voluttuosa preziosità dei dettagli couture, come gli inserti in cuoio ispirati al mondo della moda.

Yume is an upholstered bed that reinterprets a classic design through visual and material lightness, thanks to a soft headboard. Designed by Jean-Marie Massaud, it combines a timeless elegance with precious couture details, such as hide inserts inspired by the world of fashion.







Nella pagina precedente: letto Yume, testata con cuscini e base imbottite con rivestimento sfoderabile in tessuto Carson 05 pernice, inserti testata in cuoio 07 castagna. Biancheria da letto coordinata in cotone Provence 03 ghiaccio con profilo bianco. Coperta Linus notte. Qui e nella pagina successiva: letto Yume, testata con cuscini e base imbottite con rivestimento sfoderabile in tessuto Brest 01 crema, inserti testata in cuoio 08 fango. Biancheria da letto coordinata in cotone Provence 03 ghiaccio con profilo bianco. Coperta Linus notte. Tavolini Mush con piano e struttura in olmo nero e nella versione completamente rivestita in cuoio 08 fango. Poltrona Kaori con scocca esterna e basamento in cuoio 07 castagna, scocca interna e seduta in pelle sfoderabile Silk 10 terracotta, piedini brown nickel opaco. Tappeto Cannelé.

Previous page: Yume bed, headboard with cushions and padded base with removable cover in fabric Carson 05 pernice, headboard inserts in hide 07 castagna. Coordinated bed linen in cotton Provence 03 ghiaccio with profile in bianco. Linus blanket notte. Here and next page: Yume bed, headboard with cushions and padded base with removable cover in fabric Brest 01 crema, hide 08 fango headboard inserts. Coordinated bed linen in cotton Provence 03 ghiaccio with profile in bianco. Linus blanket notte. Mush coffee tables with top and structure in black elm and, in this version, fully covered in hide 08 fango. Kaori armchair with outer shell and base in hide 07 castagna, inner shell and seat in removable leather Silk 10 terracotta, mat brown nickel feet. Cannelé carpet.





## YUME

Design Jean-Marie Massaud

Letto con testata imbottita in poliuretano stampato con prerivestimento in fibra di poliestere, inserti laterali in cuoio.  
Base letto in legno e derivati con imbottitura in poliuretano espanso monoquota, prerivestimento in fibra di poliestere.  
Cuscini per testata opzionali, imbottitura in fibra di poliestere, prerivestimento in tela cotone.  
Rivestimento sfoderabile in tessuto o pelle, inserti laterali della testata in cuoio colori.

### Predisposto per materassi:

l 1700-1800 x p 2000

**Queen size** letto l 1625-2635 x p 2200

materasso l 1525 x p 2030

**King size** letto l 2030-2880 x p 2200

materasso l 1930 x p 2030

### Tipologia di rete:

- rete fissa
- reti anatomiche

Bed with padded headboard in moulded polyurethane with polyester fibre pre-cover, side inserts in hide.  
Bed base in wood and wood-derivatives with padding in polyurethane foam, pre-cover in polyester fibre.  
Optional headboard cushions, polyester fibre padding, pre-cover in cotton canvas.  
Removable cover in fabric or leather, headboard side inserts in hide in the sample colours.

### For mattresses:

w 67"- 70 3/4" x d 78 3/4"

**Queen size** bed w 64"-103 3/4" x d 86 1/2"

for mattress w 60" x d 80"

**King size** bed w 80"- 113 1/2" x d 86 1/2"

for mattress w 76" x d 80"

### Bedstead type:

- fixed bedstead
- anatomic bedsteads

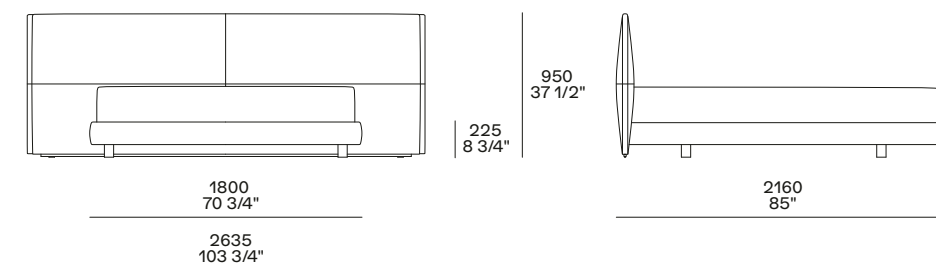

per materasso l 1700 e Queen size  
for mattress w 67" and Queen size

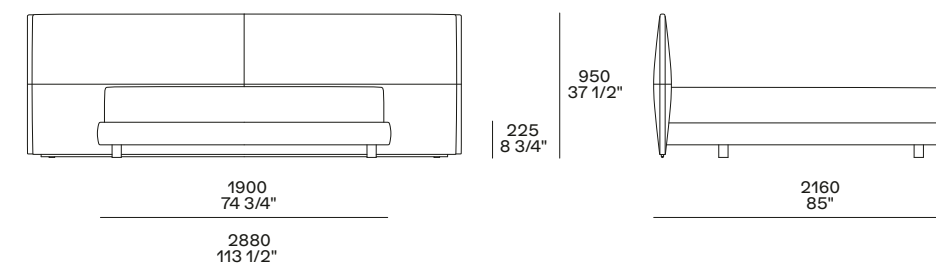

per materasso l 1800 e King size  
for mattress w 70 3/4" and King size

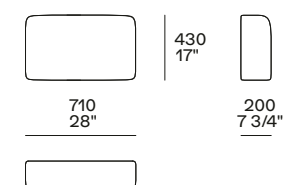

cuscino opzionale per Queen size  
optional cushion for Queen size

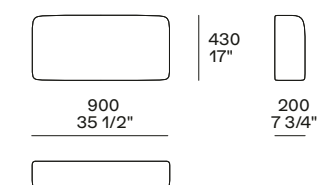

cuscino opzionale per materasso l 1700-1800 e King size  
optional cushion for mattress w 67"-70 3/4" and King size

# CURVE

Curve nasce dall'esigenza di creare un letto leggero ed essenziale, che porti in sé le caratteristiche di eleganza e di atemporalità di Poliform. Il lavoro di Emmanuel Gallina prosegue dunque nel solco della collezione Curve, sottraendo materia per raggiungere una leggerezza delicata e contemporanea. La testiera, rivestita in tessuto o in pelle, è imbottita in modo da risultare soffice e confortevole in qualsiasi punto.

Curve was born from the need to create a light and essential bed, which embodies Poliform's distinctive elegance and timelessness. Emmanuel Gallina's work continues in the vein of the Curve collection, stripping down the material to achieve a delicate and contemporary lightness. The padded headboard, upholstered in fabric or leather, is extremely soft and comfortable.

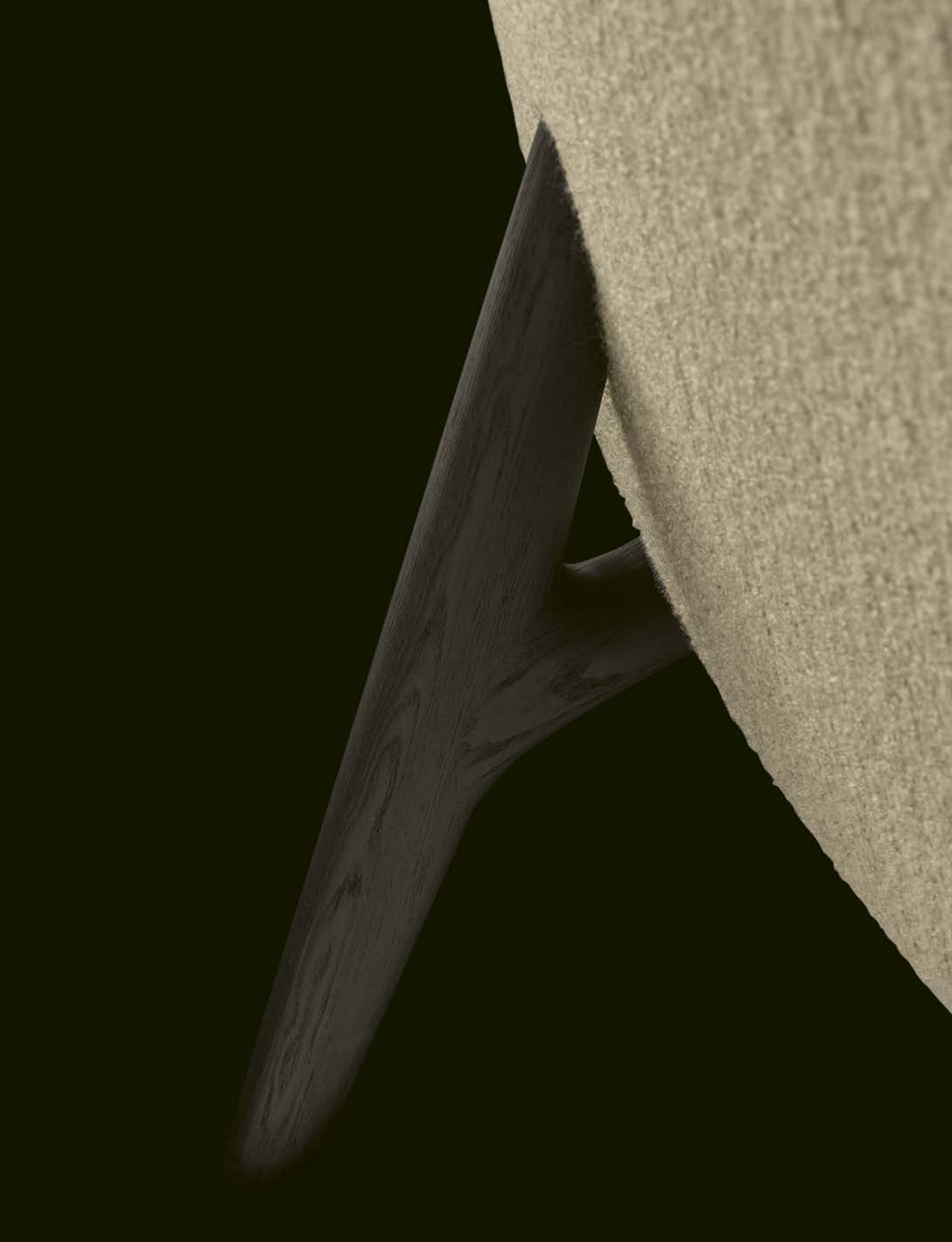



Nella pagina precedente: letto Curve, testata imbottita con rivestimento sfoderabile in tessuto Lero 01 écreu, base letto in olmo nero e rivestimento sfoderabile in tessuto Lero 01 écreu. Rulli in pelle sfoderabile Nabuk 01 latte. Biancheria da letto coordinata in cotone Provence 08 polvere con profilo bianco. Coperta Linus granata. Qui e nella pagina successiva: letto Curve, testata imbottita con rivestimento sfoderabile in tessuto Komi 06 bruciato, base letto in olmo nero e rivestimento sfoderabile in tessuto Komi 06 bruciato. Rulli in pelle sfoderabile Silk 10 terracotta. Biancheria da letto coordinata in cotone Provence 08 polvere con profilo polvere. Coperta Linus latte. Comodini Kelly in olmo nero e top in marmo zecevo levigato. Poltrona Curve con struttura in olmo nero e rivestimento non sfoderabile in tessuto Agadir 08 foresta. Consolle Nara in legno massello noce gold. Specchio Circle con cornice in cuoio 26 invecchiato e specchio bianco. Pouf New York in tessuto sfoderabile Antea 05 terra di siena. Tappeto Cannelé.

Previous page: Curve bed, padded headboard with removable cover in fabric Lero 01 ecru, black elm bed base and removable cover in fabric Lero 01 ecru. Removable leather roll cushions Nabuk 01 latte. Coordinated bed linen in cotton Provence 08 polvere with profile in bianco. Linus blanket granata. Here and next page: Curve bed, padded headboard with removable cover in fabric Komi 06 bruciato, black elm bed base and removable cover in fabric Komi 06 bruciato. Removable leather roll cushions in leather Silk 10 terracotta. Coordinated bed linen in cotton Provence 08 polvere with profile in polvere. Linus blanket latte. Kelly night tables in black elm and top in mat zecevo marble. Curve armchair with black elm structure and non-removable cover in fabric Agadir 08 foresta. Nara console table in solid wood gold walnut. Circle mirror, frame in hide 26 invecchiato and white mirror. New York pouf in removable fabric Antea 05 terra di siena. Cannelé carpet.









## CURVE

Design Emmanuel Gallina

Letto con testata imbottita in poliuretano stampato con prerivestimento in fibra di poliestere.

Base letto con piedi in legno massello nella finitura rovere spessart o olmo nero e guide in metallo rivestito.

Rivestimento sfoderabile in tessuto o pelle. Coppia rulli opzionale con rivestimento sfoderabile in tessuto o pelle.

**Predisposto per materassi:**  
l 1700-1800 x p 2000

**Tipologia di rete:**  
- rete fissa in metallo  
- reti anatomiche

Bed with padded headboard in moulded polyurethane with polyester fibre pre-cover.

Bed base with solid wood feet in spessart oak or black elm finish and covered metal rails.

Removable cover in fabric or leather. Optional pair of roll cushions with removable cover in fabric or leather.

**For mattresses:**  
w 67"- 70 3/4" x d 78 3/4"

**Bedstead type:**  
- fixed bedstead in metal  
- anatomic bedsteads

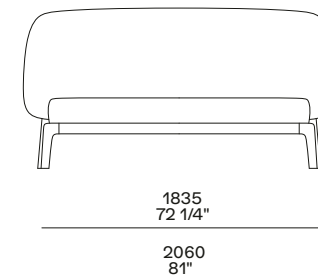

per materasso l 1700  
for mattress w 67"

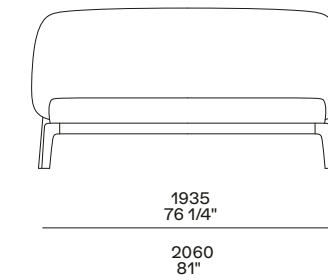

per materasso l 1800  
for mattress w 70 3/4"

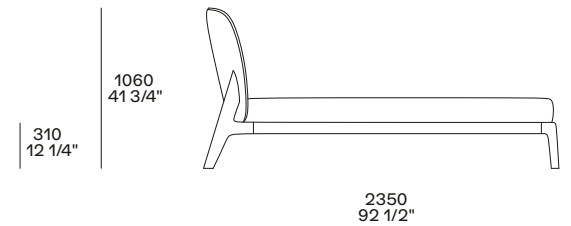



# SENZAFINE MATCH

Senzafine Match è la nuova anta del sistema Senzafine, il sistema modulare per la zona notte caratterizzato dalle infinite possibilità estetiche e funzionali. L'anta Match è disponibile in essenza con maniglia coordinata rivestita in essenza; in tecnocover con maniglia coordinata rivestita in tecnocover; in tessuto e in laccato con maniglia in metallo verniciato ardesia o champagne. Nelle versioni tessuto e tecnocover, l'anta è caratterizzata dai traversini sottili in metallo verniciato.

Senzafine Match is the new door of Senzafine, the modular system for the bedroom that stands out for its endless aesthetic and functional possibilities. The Match door is available in wood with matching wood handle; in tecnocover with matching covered handle; in fabric or lacquered with painted metal handle in ardesia or champagne. In the fabric and tecnocover versions, the door features slender painted metal crosspieces.







Nella pagina precedente: armadi Senzafine Match con ante battenti in tecnocover Grain 05 latte e profili champagne opaco, maniglie Match in tecnocover Grain 05 latte e champagne opaco. Poltrona Kaori, con scocca esterna e basamento in cuoio 07 castagna, scocca interna e seduta in pelle sfoderabile Silk 10 terracotta, piedini brown nickel opaco. Tavolino Mush con piano e struttura in olmo nero. Panca Nara in legno massello noce gold. Tappeto Plain natural. A sinistra: armadi Senzafine Match con ante battenti in rovere spessart, maniglie Match in rovere spessart e ardesia opaco. Poltrona Curve con struttura in olmo nero e rivestimento non sfoderabile in tessuto Siro 01 bianco. Consolle Nara in legno massello tinto olmo nero. Tavolino Soori in metallo finitura bronzo anticato. Tappeto Plain natural.

Previous page: Senzafine Match wardrobes with leaf doors in tecnocover Grain 05 latte and mat champagne profiles, Match handles in tecnocover Grain 05 latte and mat champagne. Kaori armchair with outer shell and base in hide 07 castagna, inner shell and seat in removable leather Silk 10 terracotta, mat brown nickel feet. Mush coffee table with top and structure in black elm. Nara bench in solid wood gold walnut. Plain carpet natural. Left: Senzafine Match wardrobes with spessart oak leaf doors, Match handles in spessart oak and mat ardesia. Curve armchair with black elm structure and non-removable cover in fabric Siro 01 bianco. Nara console table in solid wood stained black elm. Soori coffee table in antique bronze-finish metal. Plain carpet natural.

# SENZAFINE MATCH

Design R&D Poliform

## Aperture

- B Battente
- C Coplanare

## Ante

- Match essenza e laccato
- Match tessuto
- Match tecnocover Grain

## Openings

- B Leaf door
- C Coplanar door

## Doors

- Match wood and lacquer
- Match fabric
- Match Grain tecnocover

## Match essenza e laccato Match wood and lacquer



rovere gold  
gold oak



rovere spessart  
spessart oak

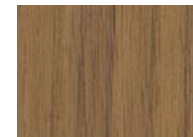

noce gold  
gold walnut



olmo nero  
black elm



27 colori - 27 colours  
laccato opaco  
mat lacquered



23 bronzo  
laccato metallico  
metallic lacquered



24 ottone  
laccato metallico  
metallic lacquered



25 titanio  
laccato metallico  
metallic lacquered

## Match tessuto Match fabric



lino chiaro  
tessuto - fabric



lino écru  
tessuto - fabric



lino bruciato  
tessuto - fabric



lino scuro  
tessuto - fabric

## Telaio e profili Frame and profiles

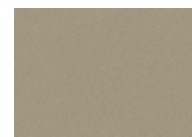

champagne opaco  
mat champagne

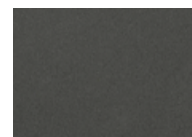

ardesia opaco  
mat ardesia

## Match tecnocover Grain Match Grain tecnocover



05 latte  
tecnocover Grain

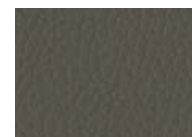

01 elefante  
tecnocover Grain



02 moro  
tecnocover Grain



06 nocciola  
tecnocover Grain

## Telaio e profili Frame and profiles



champagne opaco  
mat champagne



ardesia opaco  
mat ardesia

## Match essenza e laccato Match wood and lacquer

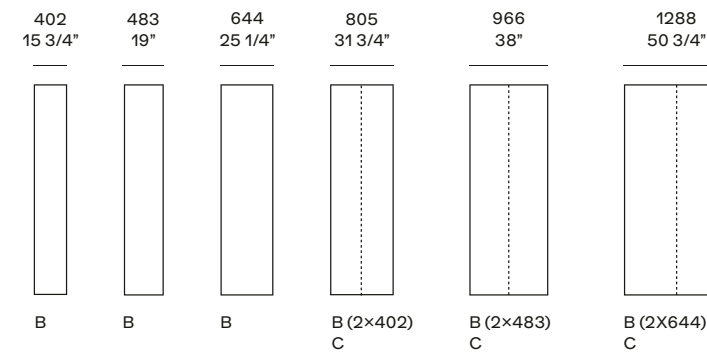

larghezze colonne  
unit widths

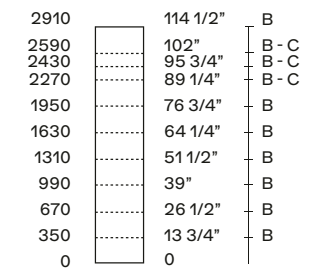

altezze colonne  
unit heights

## Match tessuto e tecnocover Grain Match fabric and Grain tecnocover

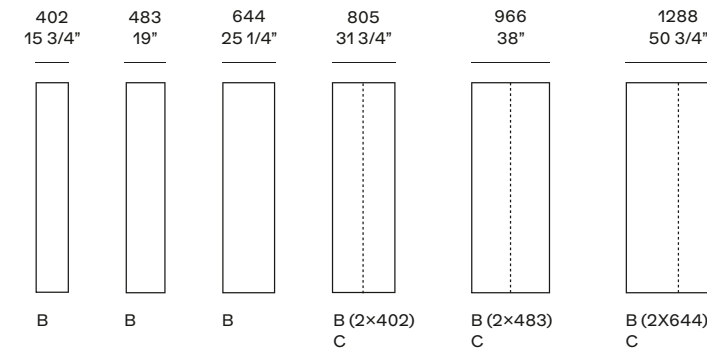

larghezze colonne  
unit widths

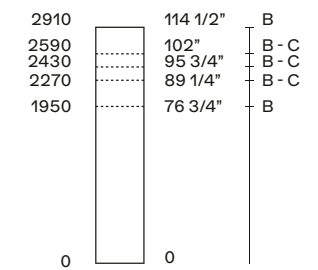

altezze colonne  
unit heights

## Maniglia Handle



**Match.** Maniglia essenza e ardesia o champagne opaco per ante in essenza - Handle in wood and mat ardesia or champagne for door in wood.



**Match.** Maniglia ardesia o champagne opaco per ante in tessuto o laccato - Handle in mat ardesia or champagne for door in fabric or lacquer.



**Match.** Maniglia ardesia o champagne opaco e tecnocover Grain 4 colori per ante in tecnocover - Handle in mat ardesia or champagne and tecnocover Grain 4 colours for door in tecnocover.

# SENZAFINE PLUS GLASS



La collezione di ante Senzafine Plus si arricchisce della nuova versione in vetro. Cinque le finiture disponibili, mentre la caratteristica maniglia Plus è declinabile nelle due finiture metalliche champagne e ardesia.

The Senzafine Plus door collection is enriched by the new glass version, available in five finishes. The characteristic Plus handle is available in the two metal finishes: champagne and ardesia.





Nella pagina precedente: armadi Senzafine Plus vetro, ante battenti in vetro trasparente riflettente con telaio ardesia opaco, maniglie Plus ardesia opaco. Interno in nobilitato rovere spessart con fianchi a telaio ardesia opaco. Cassettiere a vetrina con piano superiore in vetro fumé, cassetto con frontale a smusso in laccato opaco ardesia, cassetti inferiori con frontali in vetro riflettente fumé con bordo e maniglia Track in ardesia opaco. Tubi appendiabiti rivestiti in tecnocover Grain 05 latte e ardesia opaco, scatole con coperchio rivestite in tessuto ardesia. Poltrona Curve con struttura in olmo nero e rivestimento non sfoderabile in tessuto Siro 01 bianco. Consolle Nara in legno massello tinto olmo nero. Tavolino Soori in metallo finitura bronzo anticato. Tappeto Plain natural.

Previous page: Senzafine Plus glass wardrobes, leaf doors in reflective transparent glass with mat ardesia frame, Plus mat ardesia handles. Interior in spessart oak melamine with mat ardesia frame sides. Showcase drawers with fumé glass top, drawer with chamfered front in mat ardesia lacquer, lower drawers with fumé reflective glass fronts with edge and Track handle in mat ardesia. Hanging rails in tecnocover Grain 05 latte and mat ardesia, boxes with lids covered in fabric ardesia. Curve armchair with black elm structure and non-removable cover in fabric Siro 01 bianco. Nara console table in solid wood stained black elm. Soori coffee table in antique bronze-finish metal. Plain carpet natural.

## SENZAFINE PLUS VETRO

Design R&D Poliform

### Aperture

B Battente

### Openings

B Leaf door

### Ante

Vetro cinque varianti

### Doors

Glass five variants

### Larghezze colonne

#### Unit widths

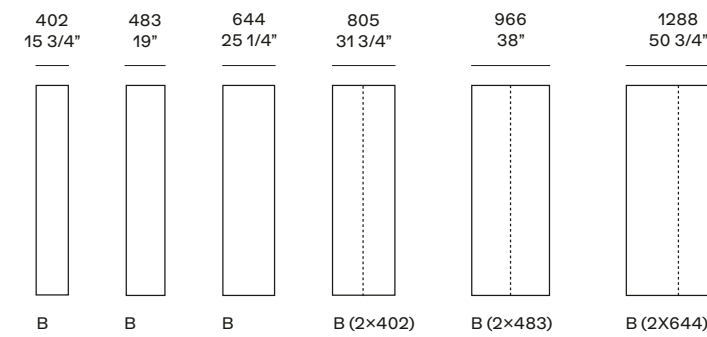

### Altezze colonne

#### Unit heights

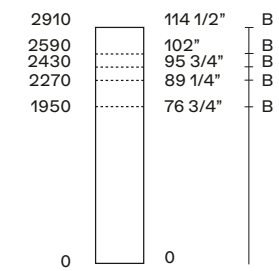

### Anta vetro

#### Glass door

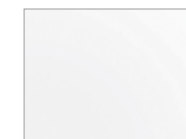

2000 trasparente  
extrachiaro-transparent  
extralight



3050 fumé

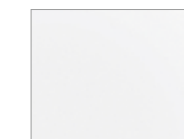

5000 trasparente  
riflettente-transparent  
reflecting



5051 riflettente bronzato  
reflecting bronzed



5059 riflettente fumé  
reflecting fumé

### Telaio, profili e maniglia

#### Frame, profiles and handle

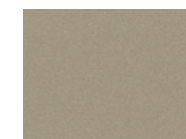

champagne opaco  
mat champagne

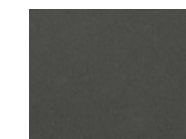

ardesia opaco  
mat ardesia

### Maniglia

#### Handle



**Plus.** Maniglia ardesia o champagne opaco - Handle in mat ardesia or champagne.

# SHINDO

La particolarità del tappeto Shindo è il disegno apparentemente in rilievo, ma dato in realtà dalla compresenza di due materiali, lana e lana e seta, che crea uno scenografico effetto ottico. Le fibre sono intrecciate a mano usando un telaio orizzontale, secondo l'antica tecnica tradizionale handloom. Perfetto complemento degli arredi Poliform, Shindo è disponibile nelle varianti grey, natural e celadon, nuance perfette da abbinare alla nuova proposta living di Poliform.

The peculiarity of the Shindo carpet is its pattern, which looks like a relief but is actually created by the contrast between two materials, wool and silk, which creates a spectacular optical effect. The fibres are woven by hand on a horizontal loom, according to the ancient traditional handloom technique. A perfect complement to Poliform furnishings, Shindo is available in grey, natural and celadon: nuances to match the latest designs in the Poliform catalogue.





## SHINDO

Design R&D Poliform

Prodotto a mano con tecnica handloom.  
Shindo celadon e grey: trama in cotone,  
vello in lana himalayana e seta di bambù.  
Shindo natural: trama in cotone, vello in aloe  
e seta di bambù.

Tappeti caratterizzati da motivo a pettine  
con cambio di passo per creare un decoro  
laterale. Nella versione rettangolare e  
quadrata il decoro è di 150 mm su entrambi  
i lati lunghi del tappeto. Nella versione tonda  
il decoro è di 1/4 del tappeto.

Dimensioni mm: rettangolare 1700×2400  
2300×3000 - 3000×4000  
quadrato 3000×3000 - rotondo Ø 2500.

Handmade with the handloom technique.  
Shindo celadon and grey: cotton weave,  
fleece in Hymalayan wool and bamboo silk.  
Shindo natural: cotton weave, fleece in  
aloe and bamboo silk.

Carpets characterized by a scallop motif  
with step change to create a lateral  
decoration. In the rectangular and square  
version, the decoration is 6" on both long  
sides of the carpet. In the round version  
the decoration is 1/4 of the carpet.

Dimensions in: rectangular 67"x94 1/2"  
90 1/2"x118" - 118"x157 1/2"  
square 118"x118" - round Ø 94 1/2".



Celadon

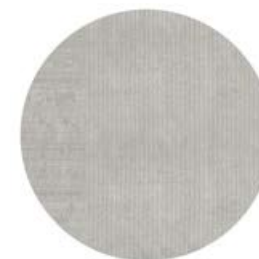

Natural



Grey

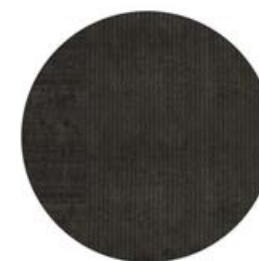



# NEW FABRICS

Una proposta che invita a interpretare il rivestimento come possibilità estetica e come veicolo di sensazioni visive e tattili. La nuova selezione di Poliform privilegia i tessuti materici, dal bouclé d'ispirazione haute couture ai jacquard di lino e viscosa dall'aspetto elegante e contemporaneo, spesso abbinati tra loro in un mix che nell'incontro tra basico e decorativo ha la sua forza. La scelta di fibre naturali certificate o provenienti da materiali rigenerati segue un'ottica di sostenibilità ed è in linea con un'idea di stile che nell'armonia tra le tonalità, nell'eleganza degli abbinamenti e nella qualità dell'esperienza esprime il suo carattere, la sua unicità e i suoi valori.

A new selection that interprets upholstery as an aesthetic possibility and a vehicle for visual and tactile sensations. The new Poliform fabrics focus on texture, from haute couture-inspired bouclé wool to linen and viscose jacquards with an elegant and contemporary look, often combined to create an enticing contrast of basic and decorative textiles. The choice of certified natural fibres or regenerated materials is not only about sustainability. It is also about an idea of style that expresses its character, uniqueness and values in a harmony of shades, elegant combinations and quality experience.





NUOVI TESSUTI  
NEW FABRICS

**Irati**  
fabric cat. d



01 avorio 02 corda 03 perla 04 sabbia 05 tortora 06 bruciato



07 celadon 08 polvere 09 argento 10 acciaio 11 ottanio

**Komi**  
fabric cat. e



01 avorio 02 corda 03 perla 04 sabbia 05 tortora 06 bruciato



07 celadon 08 polvere 09 argento 10 acciaio 11 ottanio

**Carson**  
fabric cat. e

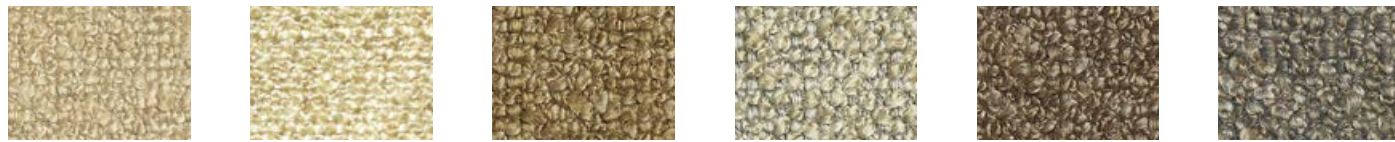

01 sabbia 02 corda 03 canapa 04 taupe 05 pernice 06 tortora



07 senape 08 roccia 09 ottanio 10 ruggine

**Molai**  
fabric cat. e



01 sabbia 02 tortora 03 avorio 04 creta 05 canapa 06 senape



07 mattone

**Yushan**  
fabric cat. m

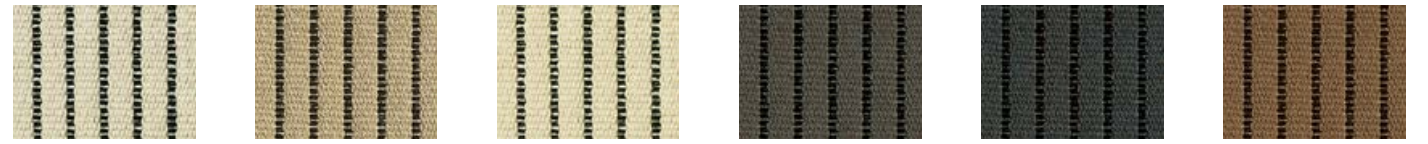

01 sabbia 02 tortora 03 avorio 04 talpa 05 grafite 06 mattone

**Kiala**  
fabric cat. d

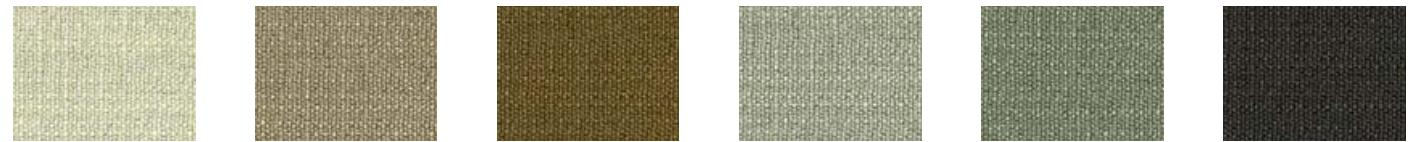

01 avorio 02 champagne 03 senape 04 argento 05 giada 06 wenge

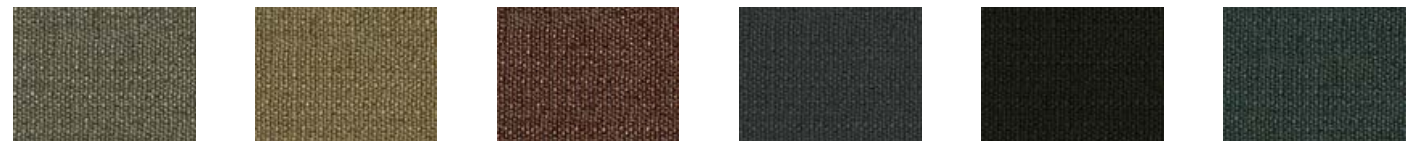

07 tortora 08 bronzo 09 mattone 10 grafite 11 nero

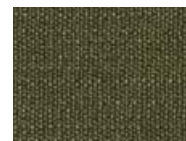

12 ottanio

**Janaki**  
fabric cat. m

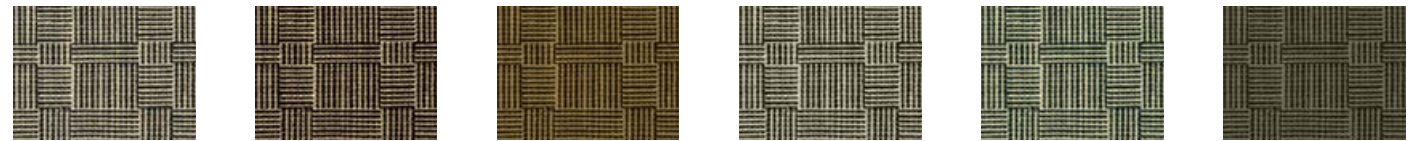

01 avorio 02 champagne 03 senape 04 argento 05 giada 06 wenge



Nelle pagine introduttive: tessuto Yushan 03 avorio e Komi 06 bruciato; tessuto Carson 05 pernice, Irati 08 polvere e Komi 08 polvere. In questa pagina: tessuto Molai 02 tortora, Yushan 02 tortora, Janaki 01 avorio e Kiala 02 champagne.

Introduction page: fabric Yushan 03 avorio and Komi 06 bruciato; fabric Carson 05 pernice, Irati 08 polvere and Komi 08 polvere. This page: fabric Molai 02 tortora, Yushan 02 tortora, Janaki 01 avorio and Kiala 02 champagne.

Massima progettualità per il divano Brera, che si presta a essere declinato nelle più diverse composizioni per creare il sistema più adatto a ciascun ambiente: da quella lineare, per i classici divani dritti o a L, a quella curva, ideale per le composizioni a semicerchio destinate agli spazi più ampi.

The Brera sofa has great design potential. The system lends itself to different configurations to best suit each environment: from classic linear or L-shaped sofas, to semi-circular compositions, ideal for larger spaces.

## BRERA SOFA

COMPOSITION 01	242
COMPOSITION 02	246
COMPOSITION 03	250
COMPOSITION 04	254
COMPOSITION 05	258
COMPOSITION 06	262

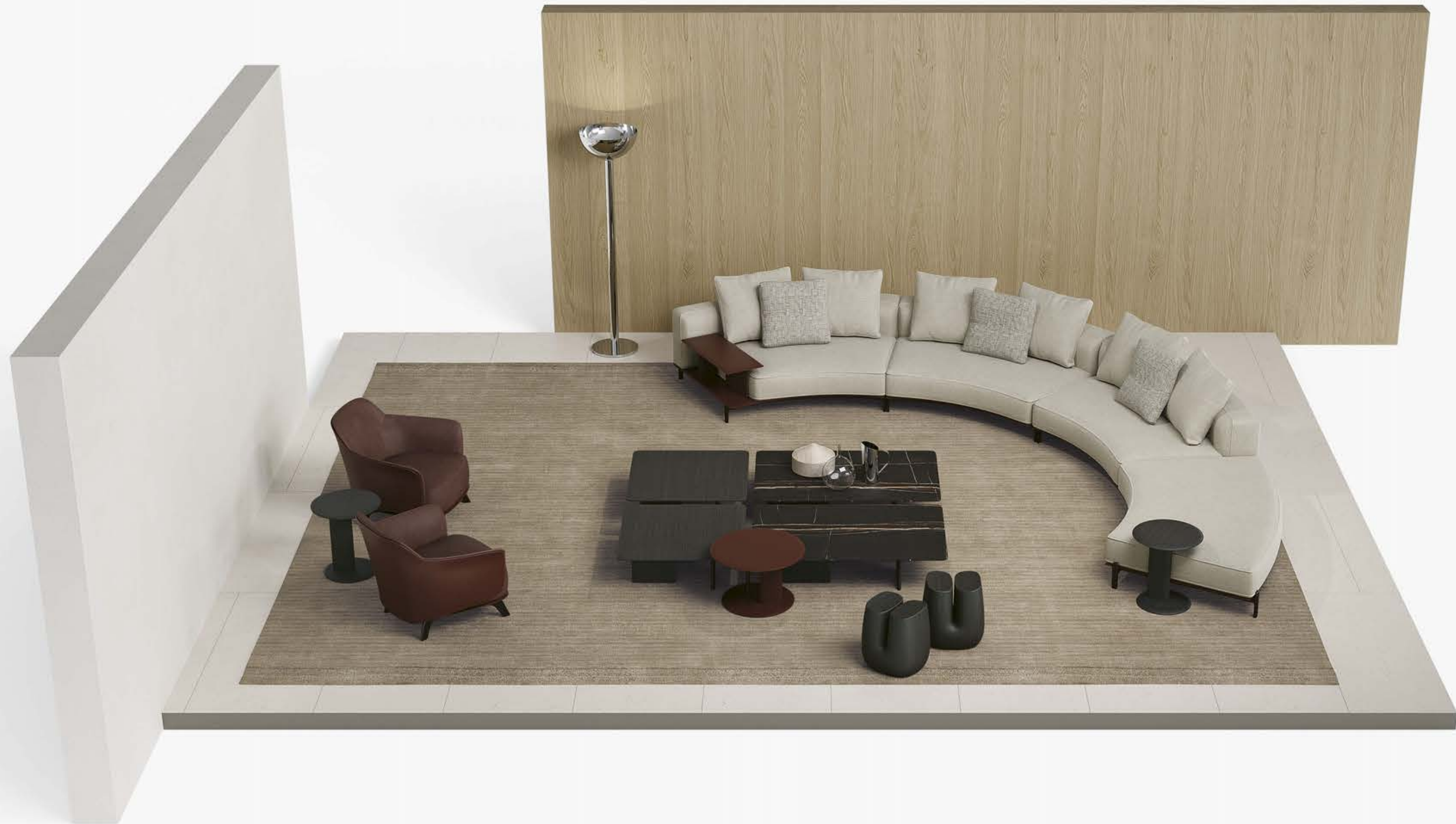

COMPOSITION 01

**1 Brera divano**  
Tessuto sfoderabile Kiala 02 champagne.  
Cuscini opzionali in tessuto sfoderabile Janaki 01 avorio.  
Basamento e bracciolo Slim in cuoio 07 castagna, piedini brown nickel opaco.  
Composizione 4161x4135

**1 Brera sofa**  
Removable fabric Kiala 02 champagne.  
Optional cushions in removable fabric Janaki 01 avorio.  
Base and Slim arm in hide 07 castagna, feet mat brown nickel.  
Composition 163 3/4"x162 3/4"

**2 Mush tavolini**  
Strutture in olmo nero.  
Piano in marmo sahara noir levigato finitura poliестere.  
1240x800 h 280  
Piano in olmo nero.  
800x800 h 280 - Ø 440 h 500  
Struttura e piano in cuoio 07 castagna.  
Ø 600 h 380

**2 Mush coffee tables**  
Structures in black elm.  
Top in mat marble sahara noir with polyester finish.  
48 3/4"x31 1/2" h 11"  
Top in black elm.  
31 1/2"x31 1/2" h 11" - Ø 17 1/4" h 19 3/4"  
Structure and top in hide 07 castagna.  
Ø 23 3/4" h 15"

**3 Kaori poltrona**  
Scocca esterna e basamento in cuoio 07 castagna, scocca interna e seduta in pelle sfoderabile Silk 10 terracotta, piedini brown nickel opaco.  
l 770 p 860 h 740

**3 Kaori armchair**  
Outer body and base in hide 07 castagna, inner body and seat in removable leather Silk 10 terracotta, feet mat brown nickel.  
w 30 1/4" d 33 3/4" h 29 1/4"

**4 Ube sgabello**  
Massello tinto olmo nero.  
l 385 p 335 h 425

**4 Ube stool**  
Solid wood stained black elm.  
w 15 1/4" d 13 1/4" h 16 3/4"

**5 Shindo tappeto**  
Colore natural.  
Dimensioni su misura 6500x5000

**5 Shindo carpet**  
Colour natural.  
Customized sizes 256"x196 3/4"

**Brera divano  
Brera sofa**

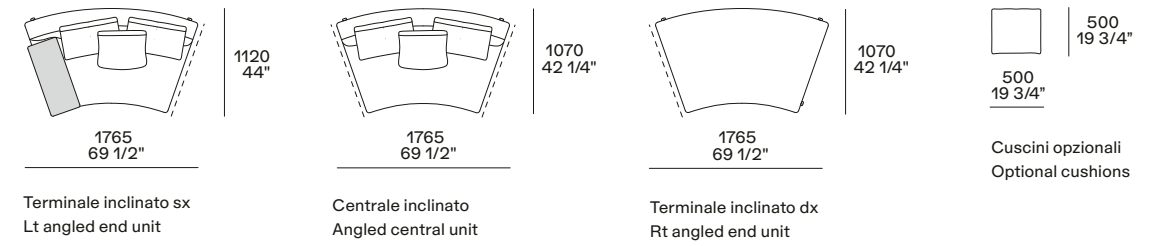

**Mush tavolini  
Mush coffee tables**

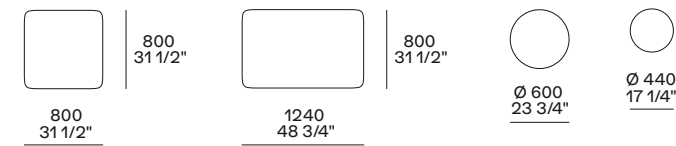

**Kaori poltrona  
Kaori armchair**

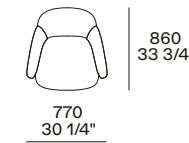

**Ube sgabello  
Ube stool**

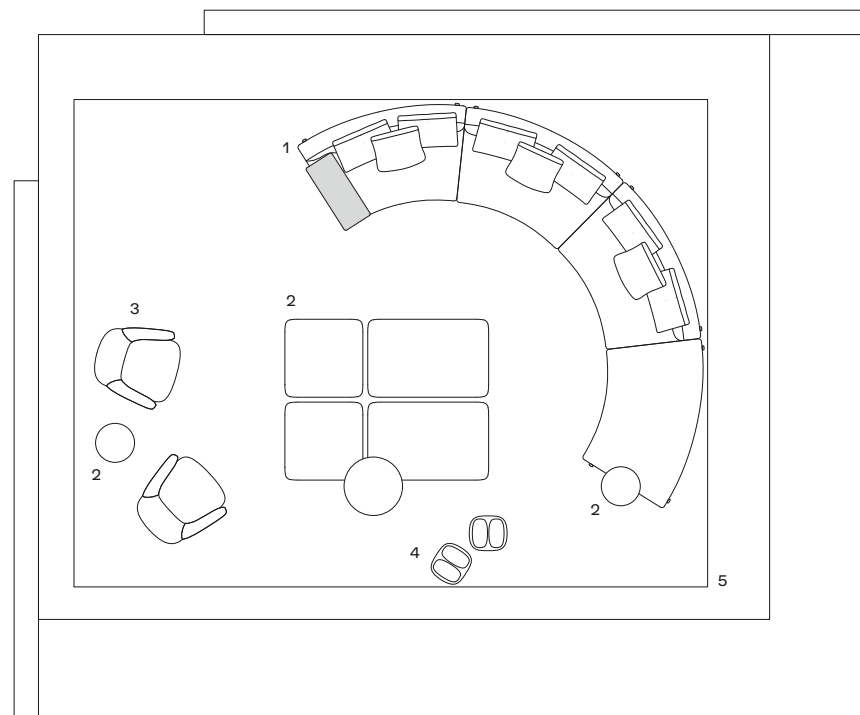

Display 45 mq-sqm

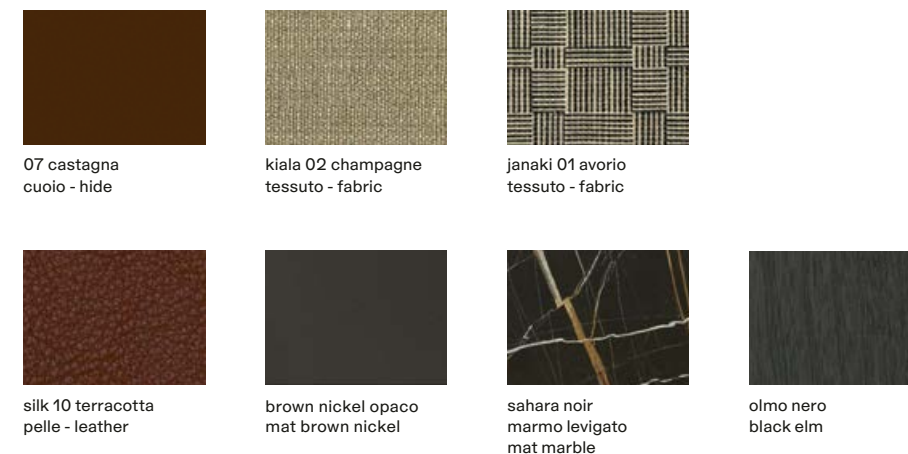



## COMPOSITION 02

### 1 Brera divano

Tessuto sfoderabile Molai 04 creta.  
Cuscini opzionali in tessuto sfoderabile  
Yushan 01 sabbia e velluto sfoderabile  
Persia 1404 carbone.  
Basamento e mensole in cuoio 08 fango,  
piedini brown nickel opaco.  
Composizione 1a 3355x4104

### 1 Brera sofa

Removable fabric Molai 04 creta.  
Optional cushions in removable fabric  
Yushan 01 sabbia and removable velvet  
Persia 1404 carbone.  
Base and shelves in hide 08 fango, feet  
mat brown nickel.  
Composition 1a 132"x161 1/2"

### 2 Mush tavolini

Strutture in olmo nero.  
Piano in marmo zecevo levigato.  
1240x1240 h 280  
Piano in olmo nero.  
800x800 h 280 - Ø 440 h 500  
Struttura e piano in cuoio 26 invecchiato.  
Ø 600 h 380 - Ø 440 h 500

### 2 Mush coffee tables

Structures in black elm.  
Top in mat marble zecevo.  
48 3/4"x48 3/4" h 11"  
Top in black elm.  
31 1/2"x31 1/2" h 11" - Ø 17 1/4" h 19 3/4"  
Structure and top in hide 26 invecchiato.  
Ø 23 3/4" h 15" - Ø 17 1/4" h 19 3/4"

### 3 Hima paravento

Struttura brown nickel opaco, corda  
colore cenere.  
l 3115 p 115 h 1000

### 3 Hima screen

Structure mat brown nickel, rope  
colour cenere.  
w 122 3/4" d 4 1/2" h 39 1/4"

### 4 Curve poltrona e pouf

Struttura in olmo nero, seduta e schienale  
in tessuto non sfoderabile Siro 01 bianco.  
poltrona l 680 p 695 h 710  
pouf l 565 p 500 h 410

### 4 Curve armchair and pouf

Structure in black elm, seat and backrest  
in non-removable fabric Siro 01 bianco.  
armchair w 26 3/4" d 27 1/4" h 28"  
pouf w 22 1/4" d 19 3/4" h 16 1/4"

### 5 Ube sgabello

Massello tinto olmo nero.  
l 385 p 335 h 425

### 5 Ube stool

Solid wood stained black elm.  
w 15 1/4" d 13 1/4" h 16 3/4"

### 6 Shindo tappeto

Colore grey.  
Dimensioni su misura 6500x4700

### 6 Shindo carpet

Colour grey.  
Customized sizes 256"x185"

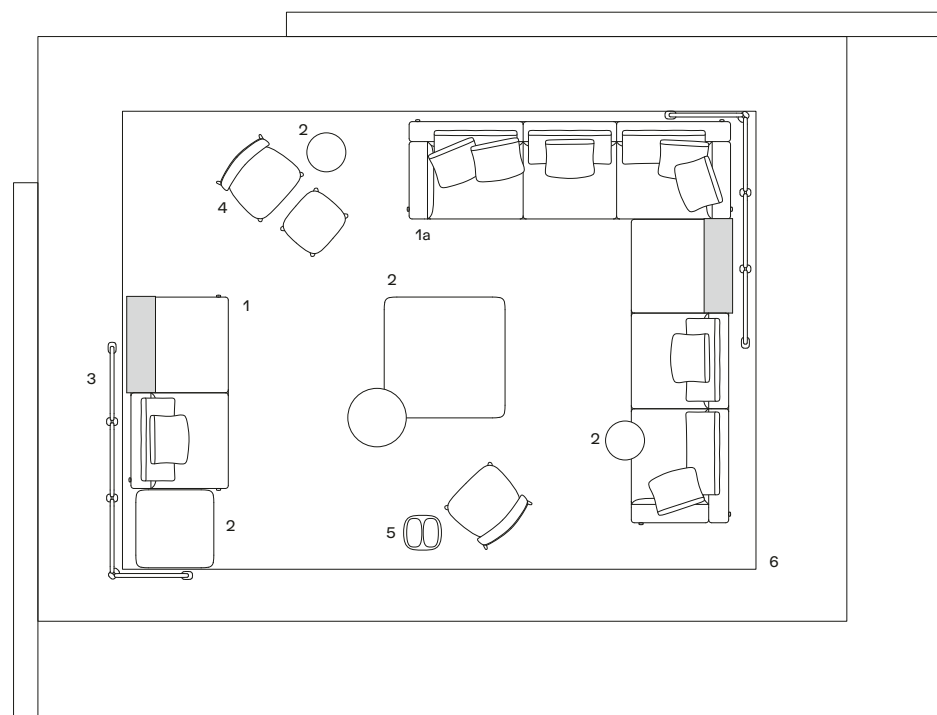

Display 48 mq-sqm

### Brera divano Brera sofa

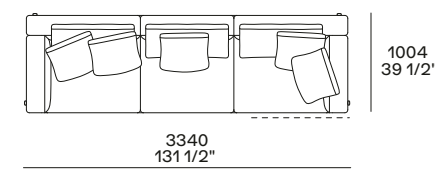

Terminale angolare sx  
Lt corner end unit

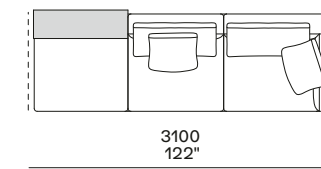

Terminale dx  
Rt end unit

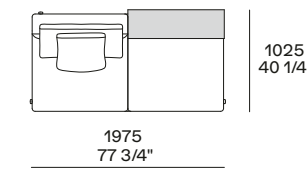

Divano sx  
Lt sofa

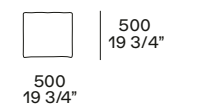

Cuscini opzionali  
Optional cushions

### Mush tavolini Mush coffee tables

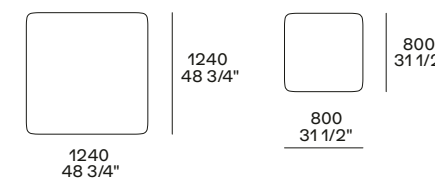

### Curve poltrona e pouf Curve armchair and pouf

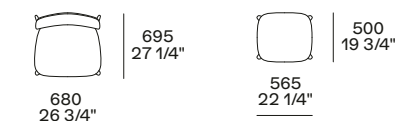

### Hima paravento Hima screen

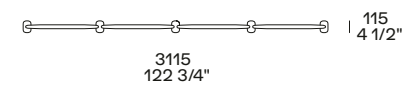

### Ube sgabello Ube stool

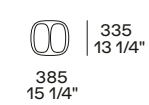

08 fango  
cuoio - hide

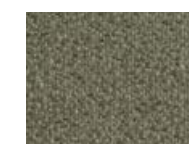

molai 04 creta  
tessuto - fabric

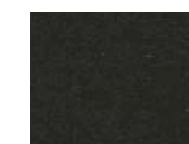

persia 1404 carbone  
velluto - velvet



yushan 01 sabbia  
tessuto - fabric



siro 01 bianco  
tessuto - fabric



olmo nero  
black elm



zecevo  
marmo levigato  
mat marble



26 invecchiato  
cuoio - hide



brown nickel opaco  
mat brown nickel

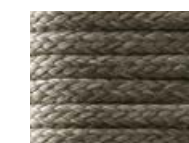

corda intrecciata cenere  
braided rope cenere





## COMPOSITION 03

### 1 Brera divano

Tessuto sfoderabile Agadir 04 tortora.  
Cuscini opzionali in tessuto sfoderabile Nancy 120 tortora e velluto sfoderabile Tebe 03 tortora.  
Basamento e bracciolo Slim in cuoio 08 fango, piedini brown nickel opaco.  
Composizione 3360x2949

### 2 Mush tavolini

Strutture in olmo nero.  
Piano in marmo bianco carrara levigato.  
Ø 1400 h 280  
Piano in olmo nero.  
800x800 h 280 - Ø 440 h 500  
Struttura e piano in cuoio 08 fango.  
Ø 600 h 380

### 3 Hima paravento

Struttura brown nickel opaco, corda colore cenere.  
l 3115 p 115 h 1000

### 4 Curve poltrona

Struttura in olmo nero, seduta e schienale in pelle non sfoderabile Silk 12 senape.  
l 680 p 695 h 710

### 5 Ube sgabello

Massello tinto olmo nero.  
l 385 p 335 h 425

### 6 Shindo tappeto

Colore grey.  
Dimensioni su misura 5700x4500

### 1 Brera sofa

Removable fabric Agadir 04 tortora.  
Optional cushions in removable fabric Nancy 120 tortora and removable velvet Tebe 03 tortora.  
Base and Slim arm in hide 08 fango, feet mat brown nickel.  
Composition 132 1/4"x116"

### 2 Mush coffee tables

Structures in black elm.  
Top in mat marble bianco carrara.  
Ø 55" h 11"  
Top in black elm.  
31 1/2"x31 1/2" h 11" - Ø 17 1/4" h 19 3/4"  
Structure and top in hide 08 fango.  
Ø 23 3/4" h 15"

### 3 Hima screen

Structure mat brown nickel, rope colour cenere.  
w 122 3/4" d 4 1/2" h 39 1/4"

### 4 Curve armchair

Structure in black elm, seat and backrest in non-removable leather Silk 12 senape.  
w 26 3/4" d 27 1/4" h 28"

### 5 Ube stool

Solid wood stained black elm.  
w 15 1/4" d 13 1/4" h 16 3/4"

### 6 Shindo carpet

Colour grey.  
Customized sizes 224 1/2"x177 1/4"

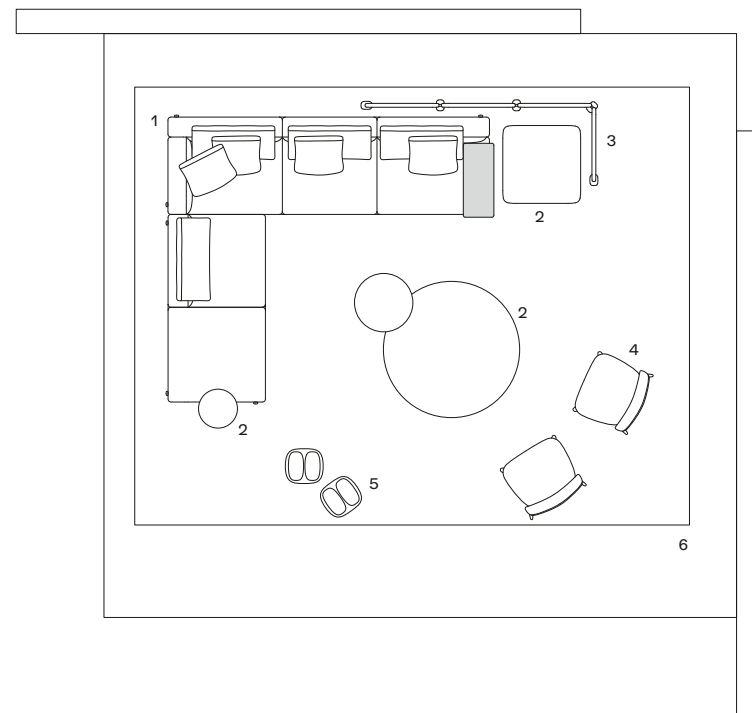

Display 39 mq-sqm

### Brera divano Brera sofa

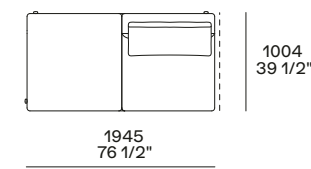

Terminale penisola sx  
Lt peninsula end unit

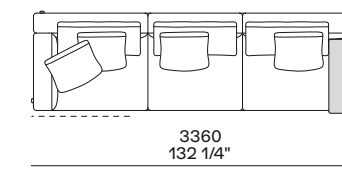

Terminale angolare dx  
Rt corner end unit

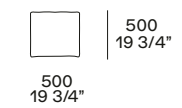

Cuscini opzionali  
Optional cushions

### Mush tavolini Mush coffee tables

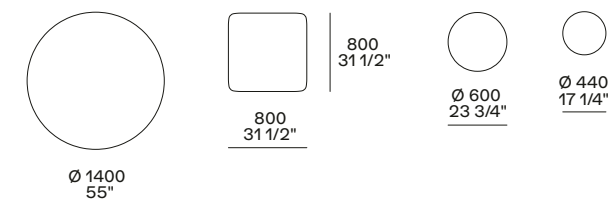

### Curve poltrona Curve armchair

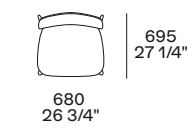

### Hima paravento Hima screen

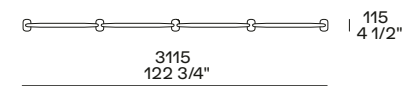

### Ube sgabello Ube stool

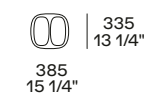

08 fango  
cuoio - hide



agadir 04 tortora  
tessuto - fabric



nancy 120 tortora  
tessuto - fabric

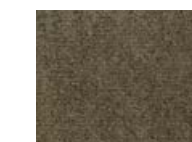

tebe 03 tortora  
velluto - velvet



silk 12 senape  
pelle - leather



olmo nero  
black elm



bianco carrara  
marmo levigato  
mat marble



brown nickel opaco  
mat brown nickel

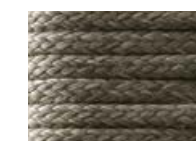

corda intreccata cenere  
braided rope cenere



COMPOSITION 04

**1 Brera divano**

Tessuto sfoderabile Naxos 16 sabbia.  
Cuscini opzionali in tessuto sfoderabile  
Yushan 06 mattone e velluto sfoderabile  
Persia 1404 carbone. Basamento,  
mensola e bracciolo Slim in cuoio 26  
invecchiato, piedini brown nickel opaco.  
Composizione 1a 2255x3827  
Composizione 1b 2296x3830

**1 Brera sofa**

Removable fabric Naxos 16 sabbia.  
Optional cushions in removable fabric  
Yushan 06 mattone and removable velvet  
Persia 1404 carbone.  
Base, shelf and Slim arm in hide 26  
invecchiato, feet mat brown nickel.  
Composition 1a 88 3/4"x150 3/4"  
Composition 1b 90 1/2"x150 3/4"

**2 Mush tavolini**

Strutture in olmo nero.  
Piano in marmo verde lepanto levigato.  
1240x800 h 280  
Piano in olmo nero.  
Ø 600 h 380 - Ø 440 h 500

**2 Mush coffee tables**

Structures in black elm.  
Top in mat marble verde lepanto.  
48 3/4"x31 1/2" h 11"  
Top in black elm.  
Ø 23 3/4" h 15" - Ø 17 1/4" h 19 3/4"

**3 Kaori poltrona**

Scocca esterna e basamento in cuoio  
08 fango, scocca interna e seduta in  
pelle sfoderabile Silk 02 beige, piedini  
brown nickel opaco.  
l 770 p 860 h 740

**3 Kaori armchair**

Outer body and base in hide 08  
fango, inner body and seat in removable  
leather Silk 02 beige, feet mat brown  
nickel.  
w 30 1/4" d 33 3/4" h 29 1/4"

**4 Ube sgabello**

Massello tinto olmo nero.  
l 385 p 335 h 425

**4 Ube stool**

Solid wood stained black elm.  
w 15 1/4" d 13 1/4" h 16 3/4"

**5 Shindo tappeto**

Colore celadon.  
Dimensioni su misura 7300x4700

**5 Shindo carpet**

Colour celadon.  
Customized sizes 287 1/2"x185"

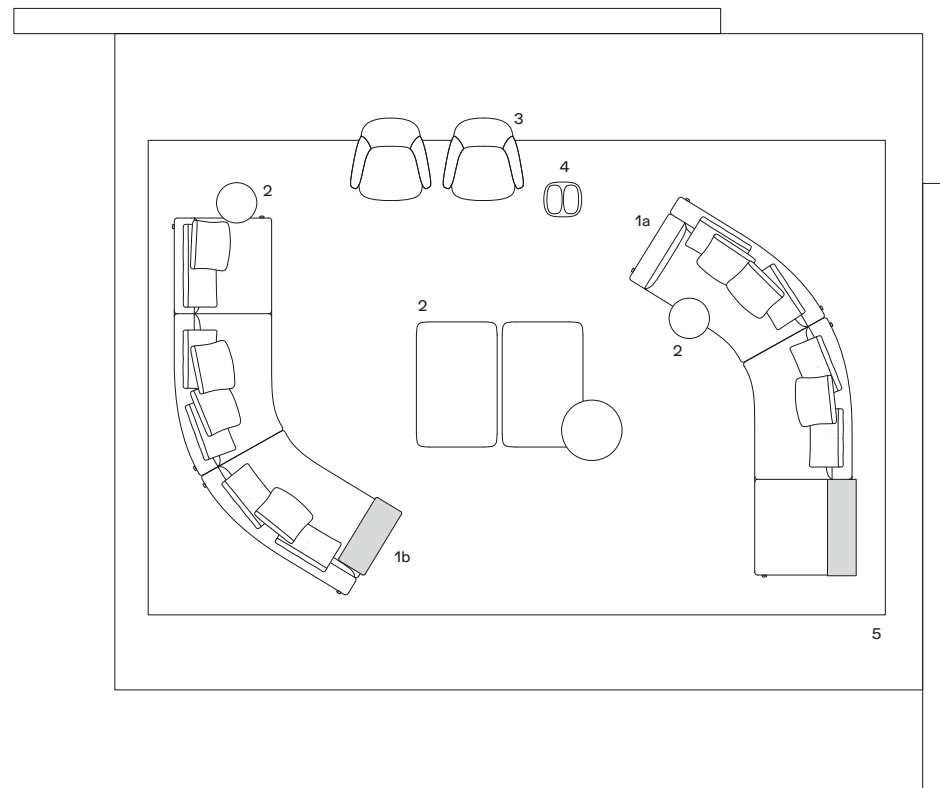

Display 52 mq-sqm

**Brera divano  
Brera sofa**

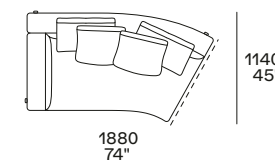

Terminale inclinato sx  
Lt angled end unit

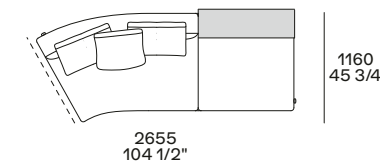

Terminale inclinato dx  
Rt angled end unit

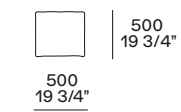

Cuscini opzionali  
Optional cushions

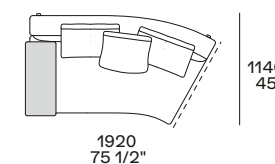

Terminale inclinato sx  
Lt angled end unit

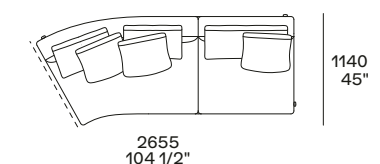

Terminale inclinato dx  
Rt angled end unit

**Mush tavolini  
Mush coffee tables**

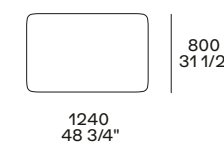

**Kaori poltrona  
Kaori armchair**

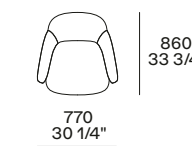

**Ube sgabello  
Ube stool**

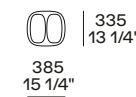

26 invecchiato  
cuoio - hide



naxos 16 sabbia  
tessuto - fabric

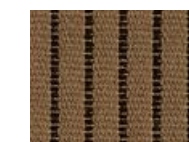

yushan 06 mattone  
tessuto - fabric

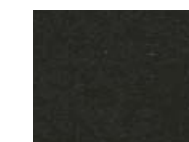

persia 1404 carbone  
velluto - velvet



silk 02 beige  
pelle - leather



08 fango  
cuoio - hide



brown nickel opaco  
mat brown nickel

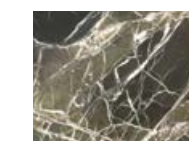

verde lepanto  
marmo levigato  
mat marble



olmo nero  
black elm



COMPOSITION 05

**1 Brera divano**

Tessuto sfoderabile Kiala 13 oliva.  
Cuscini opzionali in tessuto sfoderabile  
Yushan 03 avorio e velluto sfoderabile  
Persia 1404 carbone.  
Basamento e bracciolo Slim in cuoio  
02 nero, piedini brown nickel opaco.

**1 Brera sofa**

Removable fabric Kiala 13 oliva.  
Optional cushions in removable fabric  
Yushan 03 avorio and removable velvet  
Persia 1404 carbone.  
Base and Slim arm in hide 02 nero,  
feet mat brown nickel.

**2 Mush tavolini**

Strutture in olmo nero.  
Piano in marmo zecevo levigato e verde  
lepanto levigato.  
800x800 h 280  
Struttura e piano in cuoio 08 fango.  
Ø 600 h 380

**2 Mush coffee tables**

Structures in black elm.  
Top in mat marble zecevo and verde  
lepanto.  
31 1/2"x31 1/2" h 11"  
Structure and top in hide 08 fango.  
Ø 23 3/4" h 15"

**3 Hima paravento**

Struttura brown nickel opaco, corda  
colore cenere.  
l 3115 p 115 h 1000

**3 Hima screen**

Structure mat brown nickel, rope  
colour cenere.  
w 122 3/4" d 4 1/2" h 39 1/4"

**4 Curve poltrona e pouf**

Struttura in olmo nero, seduta e schienale  
in tessuto non sfoderabile Siro 01 bianco.  
poltrona l 680 p 695 h 710  
pouf l 565 p 500 h 410

**4 Curve armchair and pouf**

Structure in black elm, seat and backrest  
in non-removable fabric Siro 01 bianco.  
armchair w 26 3/4" d 27 1/4" h 28"  
pouf w 22 1/4" d 19 3/4" h 16 1/4"

**5 Ube sgabello**

Massello tinto olmo nero.  
l 385 p 335 h 425

**5 Ube stool**

Solid wood stained black elm.  
w 15 1/4" d 13 1/4" h 16 3/4"

**6 Shindo tappeto**

Colore natural.  
Dimensioni su misura 5500x4000

**6 Shindo carpet**

Colour natural.  
Customized sizes 216 1/2"x157 1/2"

**Brera divano  
Brera sofa**

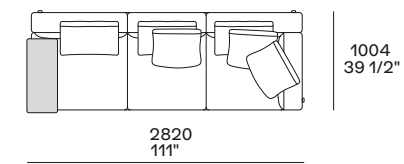

Divano sx  
Lt sofa

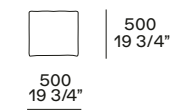

Cuscini opzionali  
Optional cushions

**Mush tavolini  
Mush coffee tables**



**Curve poltrona e pouf  
Curve armchair and pouf**

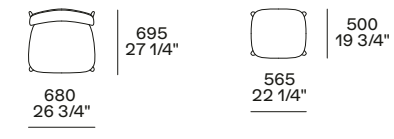

**Hima paravento  
Hima screen**

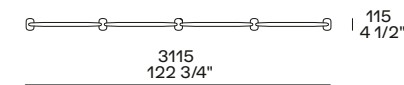

**Ube sgabello  
Ube stool**

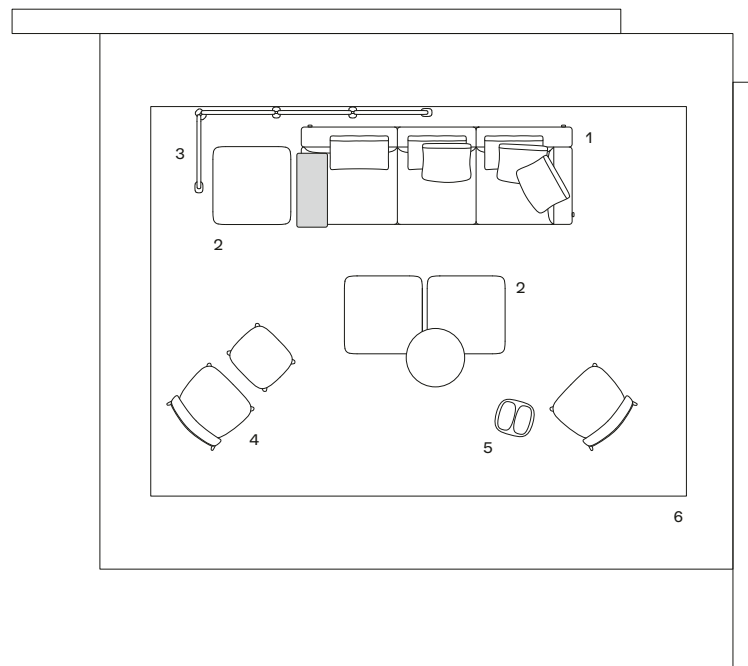
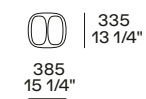

Display 36 mq-sqm



02 nero  
cuoio - hide

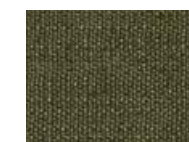

kiala 13 oliva  
tessuto - fabric

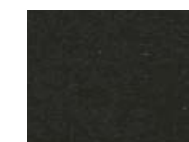

persia 1404 carbone  
velluto - velvet

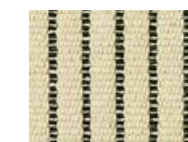

yushan 03 avorio  
tessuto - fabric



brown nickel opaco  
mat brown nickel



siro 01 bianco  
tessuto - fabric



olmo nero  
black elm

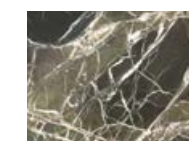

verde lepanto  
marmo levigato  
mat marble



08 fango  
cuoio - hide



zecevo  
marmo levigato  
mat marble

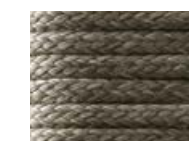

corda intrecciata cenere  
braided rope cenere



COMPOSITION 06

**1 Brera divano**

Tessuto sfoderabile Kiala 08 bronzo.  
Cuscini opzionali in tessuto sfoderabile Janaki 02 champagne e velluto sfoderabile Persia 1404 carbone.  
Basamento e bracciolo Slim in cuoio 08 fango, piedini brown nickel opaco.  
Composizione 1a 2465x4200  
Composizione 1b 3117x3475

**1 Brera sofa**

Removable fabric Kiala 08 bronzo.  
Optional cushions in removable fabric Janaki 02 champagne and removable velvet Persia 1404 carbone.  
Base and Slim arm in hide 08 fango, feet mat brown nickel.  
Composition 1a 97"x165 1/4"  
Composition 1b 122 3/4"x136 3/4"

**2 Mush tavolini**

Strutture in olmo nero.  
Piano in marmo sahara noir levigato finitura poliesteri.  
Ø 1400 h 280  
Piano in olmo nero.  
Ø 440 h 500  
Struttura e piano in cuoio 02 nero.  
Ø 600 h 380

**2 Mush coffee tables**

Structures in black elm.  
Top in mat marble sahara noir with polyester finish.  
Ø 55" h 11"  
Top in black elm.  
Ø 17 1/4" h 19 3/4"  
Structure and top in hide 02 nero.  
Ø 23 3/4" h 15"

**3 Kaori poltrona**

Scocca esterna e basamento in cuoio 02 nero, scocca interna e seduta in pelle sfoderabile Silk 08 nero, piedini brown nickel opaco.  
l 770 p 860 h 740

**3 Kaori armchair**

Outer body and base in hide 02 nero, inner body and seat in removable leather Silk 08 nero, feet mat brown nickel.  
w 30 1/4" d 33 3/4" h 29 1/4"

**4 Ube sgabello**

Massello tinto olmo nero.  
l 385 p 335 h 425

**4 Ube stool**

Solid wood stained black elm.  
w 15 1/4" d 13 1/4" h 16 3/4"

**5 Shindo tappeto**

Colore celadon.  
Dimensioni su misura 6500x5000

**5 Shindo carpet**

Colour celadon.  
Customized sizes 256"x196 3/4"

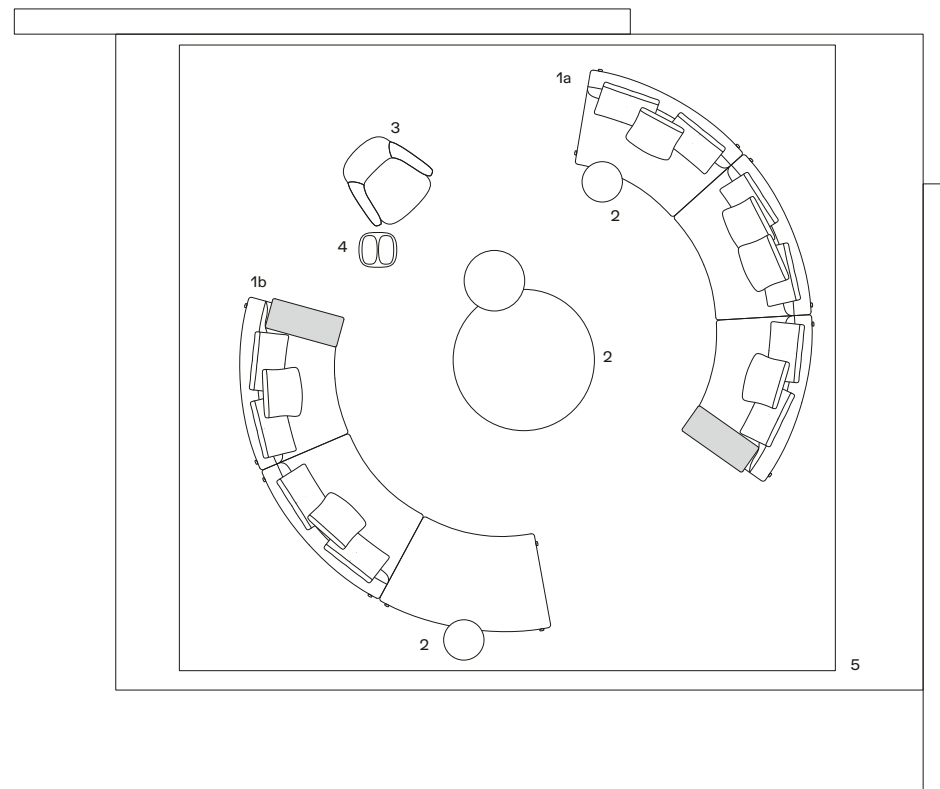

Display 52 mq-sqm

**Brera divano  
Brera sofa**

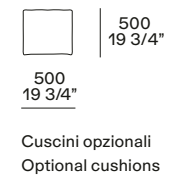
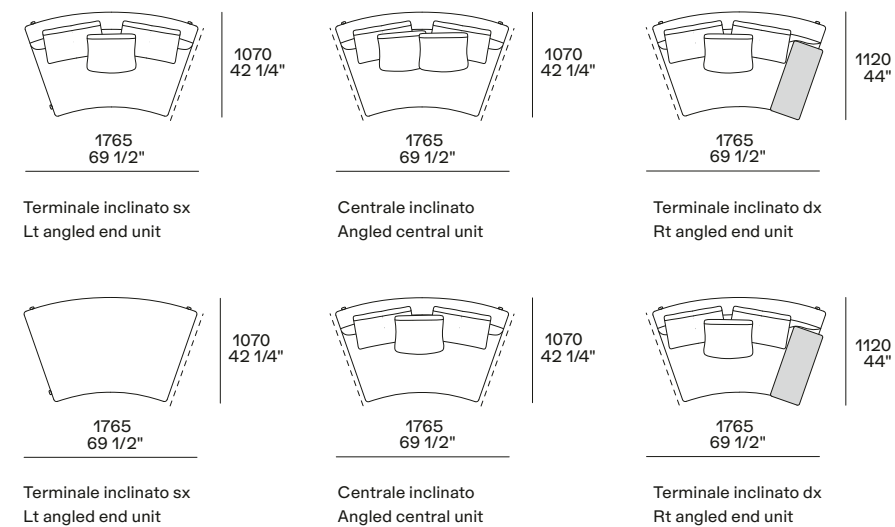

**Mush tavolini  
Mush coffee tables**

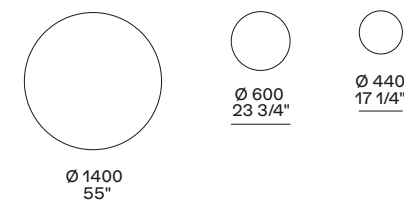

**Kaori poltrona  
Kaori armchair**

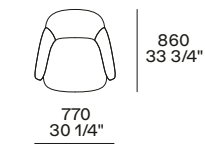

**Ube sgabello  
Ube stool**

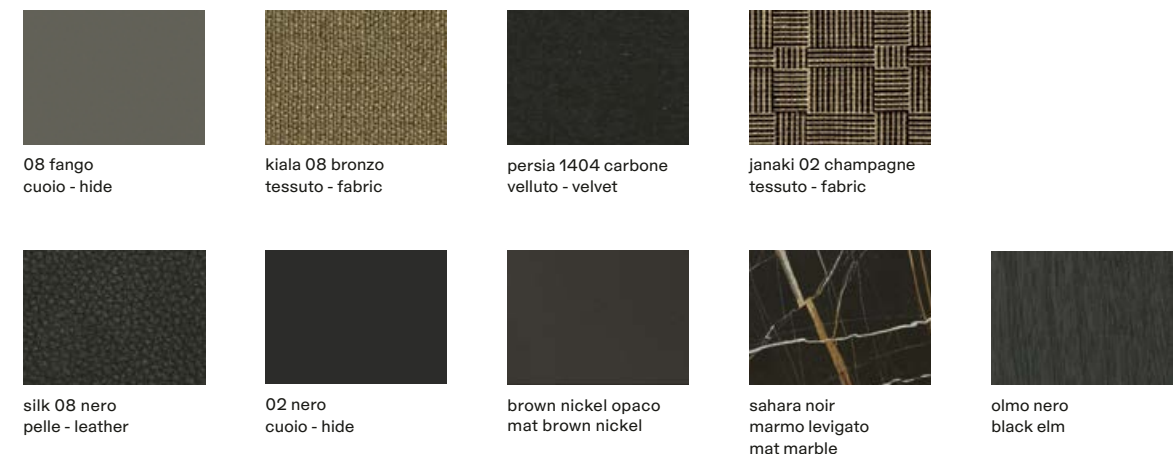
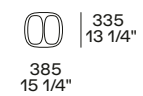





FINITURE  
FINISHINGS

**Laccato opaco**  
**Mat lacquer**



82 glacier white



01 bianco



35 canapa



26 corda



88 castoro



46 tortora



64 arena

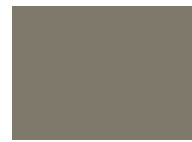

89 roccia



48 visone



49 moka



04 grafite



91 carbone



60 ghiaccio



09 pioggia



78 ferro



83 ocre



85 caramello



67 muschio



92 vischio



87 granata



86 danubio



70 prussia



77 champagne



24 ottone



23 bronzo



90 piombo



02 ardesia

**Laccato lucido**  
**Glossy lacquer**

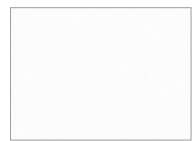

82 glacier white

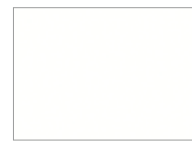

01 bianco



35 canapa



26 corda



46 tortora

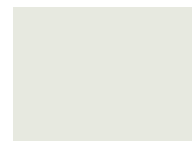

60 ghiaccio



48 visone



49 moka



83 ocre



85 caramello



87 granata

● news

**Essenza**  
**Wood**



rovere gold  
gold oak



rovere spessart  
spessart oak

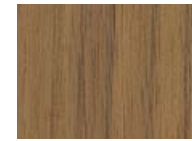

noce gold  
gold walnut



olmo nero  
black elm



massello noce canaletto  
solid walnut canaletto



cedro  
cedar



noce  
walnut

**Essenza Print**  
**Wood Print**



rovere gold print  
gold oak print



rovere spessart print  
spessart oak print



noce gold print  
gold walnut print



olmo nero print  
black elm print

**Laccato metallico**  
**Metallic lacquer**



23 bronzo



24 ottone



25 titanio

**Laccato antigraffio**  
**Antiscratch lacquer**



01 bianco



35 canapa



04 grafite



91 carbone

FINITURE  
FINISHINGS

**Cuoio  
Hide**



28 avorio



29 tortora



08 fango ●



19 caffè



38 oliva



26 invecchiato



07 castagna ●



03 grigio scuro



02 nero

**Tecnocover Grain  
Grain tecnocover**



05 latte

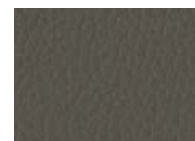

01 elefante

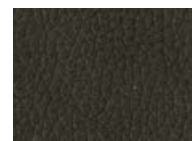

02 moro



06 nocciola

**Tessuto  
Fabric**



lino chiaro



lino écru



lino bruciato



lino scuro

**Inalco MDi®  
Inalco MDi®**



rigato chiaro ●

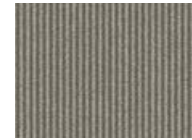

rigato scuro ●

**Midollino  
Wicker**



finitura olmo nero ●  
black elm finishing

**Corda intrecciata  
Braided rope**



cenere ●

**Marmo levigato  
Mat marble**



bianco carrara



calacatta oro



verde lepanto



grigio stardust



emperador dark



sahara noir  
finitura poliestere  
polyester finish



zecevo

**Marmo lucido  
Glossy marble**



bianco carrara



calacatta oro



verde lepanto



grigio stardust



emperador dark



sahara noir  
finitura poliestere  
polyester finish



noir saint laurent

**Gabbro  
Gabbro**



nero assoluto  
texture juta

**Onice  
Onyx**



ambra  
amber

**Semiprezioso  
Semiprecious stone**

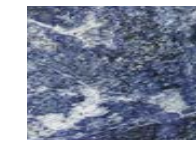

lapislazzulo blu  
blue lapis lazuli

**Pietra spatolata  
Spatula-finish stone**

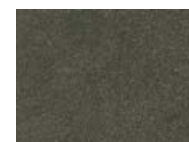

ebano  
ebony

**Grès porcellanato lucido  
Glossy gres porcelain**

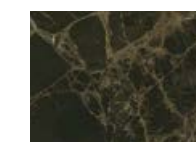

emperador dark



calacatta oro

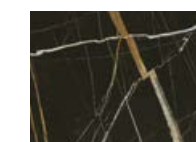

sahara noir

● news

# FINITURE FINISHINGS

## Tessuti Fabrics



caleo cat. b  
15 colori - colours



chios cat. b  
13 colori - colours



eraclea cat. b  
12 colori - colours

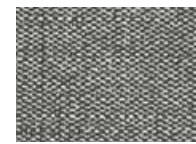

lima cat. c  
11 colori - colours

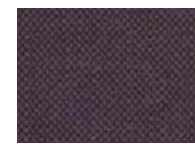

siviglia cat. c  
14 colori - colours



antea cat. d  
13 colori - colours



corinto cat. d  
5 colori - colours



irati cat. d ●  
11 colori - colours



itaca cat. d  
10 colori - colours



kiala cat. d ●  
13 colori - colours



kushiro cat. d  
13 colori - colours



micene cat. d  
9 colori - colours



milos cat. d  
5 colori - colours

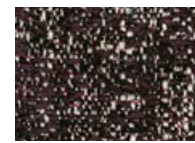

olimpia cat. d  
14 colori - colours

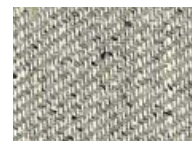

oxford cat. d  
8 colori - colours

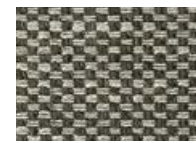

rabat cat. d  
10 colori - colours

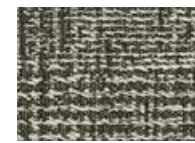

sendai cat. d  
5 colori - colours



sparta cat. d  
12 colori - colours



agadir cat. e  
9 colori - colours



arcadia cat. e  
12 colori - colours



argo cat. e  
13 colori - colours



carson cat. e ●  
10 colori - colours

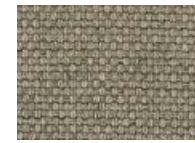

hannover cat. e  
11 colori - colours

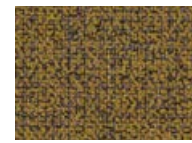

kitami cat. e  
12 colori - colours

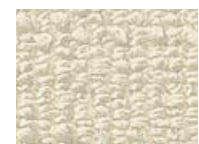

komi cat. e ●  
11 colori - colours



molai cat. e ●  
7 colori - colours



naxos cat. e  
11 colori - colours



nayoro cat. e  
10 colori - colours



orleans cat. e  
10 colori - colours



persia cat. e  
16 colori - colours



skyros cat. e  
12 colori - colours



brest cat. g  
10 colori - colours



dundee cat. g  
6 colori - colours



glasgow cat. g  
6 colori - colours



lero cat. g  
2 colori - colours



nancy cat. g  
6 colori - colours

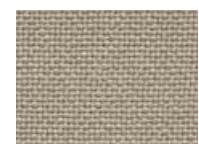

norwich cat. g  
8 colori - colours



sheffield cat. g  
9 colori - colours



siro cat. g  
4 colori - colours



tebe cat. g  
11 colori - colours



janaky cat. m ●  
6 colori - colours

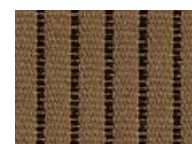

yushan cat. m ●  
6 colori - colours



gibson cat. z  
6 colori - colours

● news

## Pelle Leather



spring cat. p  
13 colori - colours

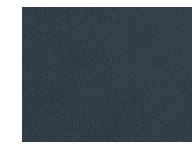

colors cat. s  
25 colori - colours

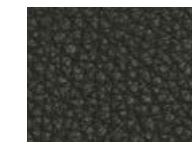

silk cat. s  
13 colori - colours



silk intrecciata cat. s  
woven leather silk  
13 colori - colours

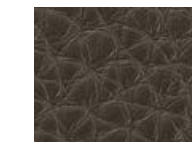

deep cat. x  
10 colori - colours



special cat. x  
21 colori - colours



nabuk cat. y  
10 colori - colours



nabuk intrecciata cat. y  
woven leather nabuk  
10 colori - colours



invecchiata cat. y  
6 colori - colours



soft cat. y  
14 colori - colours

## Pelliccia Cashmere Cashmere fur



bianco

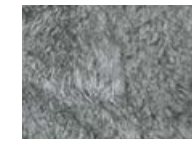

grigio



nero



bianco/nero



cappuccino

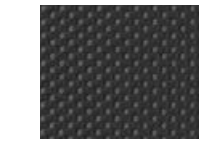

nero

## Pelle Hairy Hairy leather

## Tecnocover Pixel Pixel tecnocover

## Bordura gros-grain - bordura in seta - filati Grosgrain border - silk border - yarns



burro



perla



nuvola \* ●



cenere \* ●



sahara

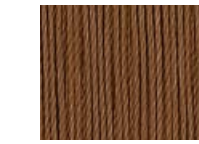

terra \* ●

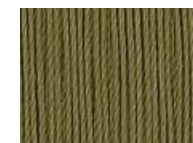

oliva \* ●



amaranto \* ●

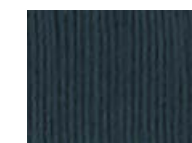

tempesta \*



navy



acciaio



nero

\* escluso bordura in seta  
except silk border

## Provence coordinati letto Bed linen Provence



01 bianco



02 panna



08 polvere



04 tortora



06 roccia



07 grafite

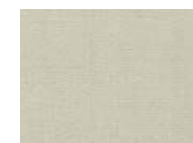

03 ghiaccio

FINITURE  
FINISHINGS

**Vetro  
Glass**

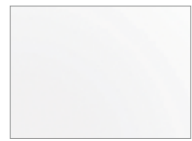

1000 trasparente  
transparent

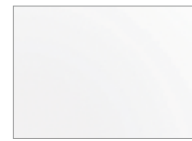

2000 trasparente  
extrachiaro-transparent  
extralight



3051 bronzato  
bronzed



3050 fumé



2700 line

**Vetro riflettente  
Reflecting glass**



5000 trasparente  
transparent



5010 blu



5051 bronzato  
bronzed



5059 fumé

**Vetro stratificato  
Stratified glass**



2C01 lino carbone  
linen carbone

**Vetro acidato  
Etched glass**



5380 acciaio



5323 bronzo



5325 titanio

**Specchio  
Mirror**



4000 bianco  
white



4051 bronzato  
bronzed

**Vetro satinato  
Mat glass**



2301 bianco extrachiaro  
extralight bianco

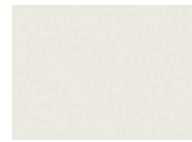

2373 ghiaccio  
ghiaccio



1335 canapa



1364 arena



1304 grafite



1303 nero

**Vetro lucido  
Glossy glass**



2201 bianco extrachiaro  
extralight bianco



2273 ghiaccio



1235 canapa



1264 arena



1204 grafite

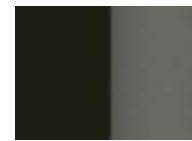

1203 nero

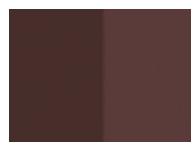

1259 bordeaux

● news

**Nobilitato  
Melamine**



olmo  
elm



noce c.  
walnut c.



rovere cenere  
cenere oak



rovere spessart  
spessart oak



canvas beige



canvas grigio



graffiti 01 bianco



graffiti 35 canapa



graffiti 60 ghiaccio



silk canapa



silk grey



silk bronzo



club 01 bianco



skin  
27 colori laccato opaco  
27 mat lacquered colours



skin 94 latte  
laccato opaco  
mat lacquered



skin 97 elefante  
laccato opaco  
mat lacquered



skin 93 moro  
laccato opaco  
mat lacquered



skin 98 nocciola  
laccato opaco  
mat lacquered

**Nobilitato interno cassetti  
Melamine drawers structure**

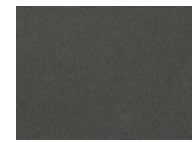

ardesia



madras  
Quid sistema giorno -  
day system



roller latte



roller ardesia

**Metacrilato  
Methacrylate**

**Parti metalliche  
Metal parts**



brown nickel opaco  
mat brown nickel



brown nickel lucido  
glossy brown nickel



brown nickel satinato  
brushed brown nickel



champagne opaco  
mat champagne



champagne satinato  
brushed champagne



ardesia opaco  
mat ardesia



cromo satinato  
brushed chrome



cromo nero lucido  
black chrome



cromo nero satinato  
brushed black chrome



bronzato  
bronzed



bronzo anticato  
antique bronze



brunito opaco  
mat brunito



spatolato ferro  
spatula-finish ferro

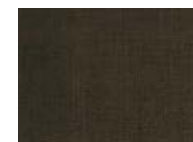

spatolato bronzo  
spatula-finish bronzo



oro lucido  
glossy gold



alluminio brill  
aluminium brill

**Poliform Spa**

via Montesanto 28  
Casella postale n. 1  
22044 Inverigo (CO) Italy  
t +39 031 6951  
f +39 031 699444  
info@poliform.it  
poliform.it



2018 Adi Compasso D'oro  
Career Award

**Poliform realizza tutte le sue collezioni in Italia usando componenti e materie prime selezionate.**

**All the Poliform collections are manufactured 100% in Italy using top-class components and materials.**

Poliform si riserva il diritto di apportare, senza preavviso, ogni modifica mirata al miglioramento funzionale e qualitativo dei propri prodotti. Testi e disegni presenti in questo stampato hanno scopo divulgativo: per ogni aspetto tecnico e dimensionale fare riferimento ai listini aziendali e relativi aggiornamenti. I campioni di colori e materiali hanno valore indicativo.

Poliform reserves the rights at all time to apply modifications for the functional or qualitative improvement of its products. Texts and drawings present in this brochure have a divulgative purpose: for every technical and dimensional aspect please refer to the company's price lists and their relative updates. The colour and material samples have an indicative value.

**Creative Direction**

Apartamento Studios

**Graphic Design**

Apartamento Studios

**Interiors Photography**

Omar Sartor

**Still Life Photography**

Silvia Orlandi

**Interiors Styling**

Poliform Lab

1st edition June 2022

cod. 128/R1/2022

Thanks to: A.G. Spalding&Bros, Anna Louise Ceramics, Atelier De Troupe, Ayres, Eyepetizer Eyewear, Gardeco, Mimmi Blomqvist, Odem Atelier, Officine Saffi, Oluce, POLSPOTTEN, Pretziada, Skultuna 1607, Studio Billie van Katwijk, Trizo21, Valextra, Valigeria Bertoni 1949, Yasha Butler, Yukari Hotta.



ASSARREDO  
FEDERLEGNOARREDO





POLIFORM.COM